



# HDL<sup>®</sup>

## HDL<sup>®</sup>

SINCE 1985

Head office

Address: No. 24 jianzhong Road, Tianhe Development  
Zone of High&New Technology Estate, Guangzhou  
510665 China

Tel: 0086 020-85571381 Fax: 0086 020-85520532

Factory base

Address: No. 86 Lotus west Road, Lifeng Street, Shilou  
Town, Panyu District, Guangzhou  
511447 China

Tel: 0086 020-84651666 Fax: 0086 020-84860772

Email: [sales@hdlautomation.com](mailto:sales@hdlautomation.com)  
[www.hdlautomation.com](http://www.hdlautomation.com)



2016/6 Edition

## BUILDING AND HOME AUTOMATION CONTROL SYSTEM





Brief Introduction

01

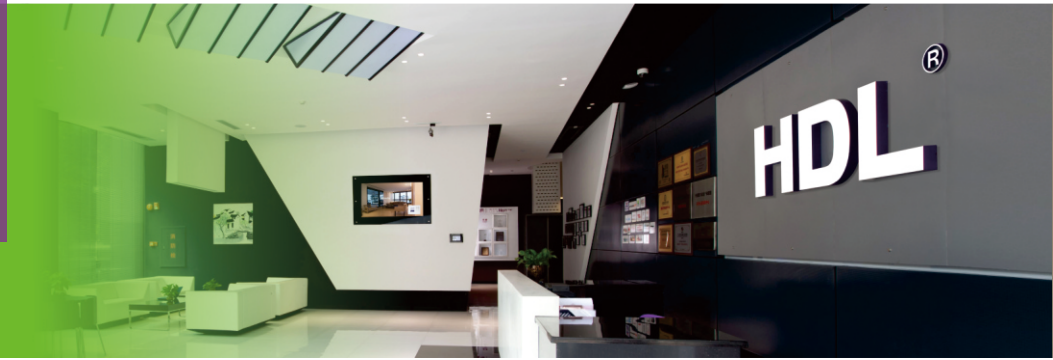

KNX Applications

05

What is KNX?

02



HDL-KNX Products

21

KNX Advantages

03



HDL-KNX Projects

55





**HDL-KNX** Building and Home Automation Control System

## Company Profile

Founded in 1985 and headquartered in Guangzhou, HDL is a global company that manufactures building automation products and professional stage lighting equipment.

All HDL systems and products are geared towards sustainable growth and sustainable savings. We at HDL know that economic and environmental balance is essential. We are proud that through our innovative products people can optimise their energy efficiency, while ensuring convenience comfort and security.

Having an extensive network of offices around the world and a presence in over 88 countries HDL is truly international. These countries are served by more than 200 well established distributors, and over 1300 dealers/installers. The reason for our global reach is simple, HDL invests in tomorrow. Our team of 70 research and development engineers have produced countless innovative products; a perfect example of this is the DLP panel which made a highly complex building automation system easy for end users to understand.

Our prime position has not gone unnoticed. We have received numerous awards internationally, and have been recognised by KNX with the coveted 'Application Award'. Owing our own factory is another source of pride for HDL. It allows us to make quick decisions and tailor products to the needs and requirements of our customers.

Although HDL leads the market we are not complacent. During manufacture we inspect each and every product, ensuring that it reaches its end user in perfect condition. After the inspection our products are then rigorously tested in various demanding environmental conditions. Because of this quality is guaranteed, and reliability assured.

Please, find more about us in [www.hdlautomation.com](http://www.hdlautomation.com)

## KNX System Introduction

What is KNX?

**HDL**®

**KNX**

**WELCOME**

— To the worldwide **STANDARD** for home and building control

International standard: ISO/IEC 14543-3

European standard: CENELEC EN 50090 and CEN EN 13321-1

United States standard: ANSI/ASHRAE 135

Chinese standard: GB/T 20965-2013

KNX is the world's only open standard for building control and automation, it can make major energy savings of up to 60%, and significantly reduce the carbon footprint of a building. This is a truly green sustainable technology that can be applied to small and large buildings alike. The standard has been adopted by many international manufacturers who together provide a vast array of KNX certified products for a range of building control applications including lighting, HVAC, intruder alarms, audio visual systems, household appliances, blinds/solar control, automatic window control, facade management, and energy control/monitoring applications.

Choosing from this pool of technology, KNX Integrators, KNX Specifiers and KNX Developers can build entire control solutions by bringing together a variety of off-the-shelf components.

As the products all 'speak the same language' and can operate together across the same network, there is less cabling and higher functionality.

KNX is increasingly being heralded by specifiers and end users as a highly desirable open solution for any building control application. The drawbacks of proprietary solutions or various hardware-based controls are being increasingly recognized. One of the most important factors with building control and automation is knowing that support is always at hand and that the system will not be obsolete in a couple of years time. With KNX this is guaranteed as there are approved and trained companies all around the world offering support at all levels for projects large and small.



HVAC



Lighting



Sunshades and blinds



Calculation



Security



Electrical appliances



A/V control



Energy management



Surveillance system



Remote control





## Advantages of KNX System

### KNX Advantages

#### What does the KNX system offer?



#### System Integrators

Utilizing KNX intelligent building system technology will help you achieve professional success!

The demands of your customers are constantly changing. In order to be independent they need promising results by employing a compatible system solution. Convenience, low energy consumption, and high reliability are the basic requirements of customers.

With constantly innovative KNX residence and building control, you can accomplish a multitude functions.

#### High Technology

- Independent installation technology and modern installation technology that accords to the European standard (CENELEC EN 50090 and CEN EN 13321-1) and International standard (ISO/IEC 14543-3).

#### Extensibility

- KNX certification process ensures the interoperability and intercommunication of different products from different manufacturers in different applications.
- The worldwide KNX standard is used to integrate different applications and products.

#### Low Risk

- The risk of electrical fires is reduced because of the lowered amount of electrical circuits used. Because of this KNX can increase security and comfort.

#### Flexibility

- It ensures high flexibility when it comes to preliminary installation schemes without affecting building modularization.
- KNX installation can easily adapt to new applications and can be easily extended.

#### Useful Installation

- Assembly time is reduced due to convenient cable arrangement.
- New components can be easily connected to an existing bus installation.

#### User-friendly Tools

- By working with user-friendly tools, relevant planning, design, device introduction and diagnosis is easily achieved.
- ETS is a unique independent engineering tool focused on the manufacturer.



#### End User

#### Why do end users select KNX?

- Safety
- High efficiency
- Comfort
- Promising investment

#### Safety

- **Alert network**  
Even when you are away, KNX is always in an alert state. The automatic intelligent residence network stays connected to the motion detector, the glass breakage sensor, the shading control, the emergency switch and your mobile phone. It ensures your protection and your safety day in, day out!
- **Quick response**  
In the event of a fire the smoke detector enables the fire alarm to alert not only you, but also other residents. Similarly, water or gas leakage may also be detected and immediately reported before damage occurs.
- **Everything is under control**  
Enjoy your vacation without worrying about the safety of your home. KNX turns your home into a castle that lets you relax in comfort and security.

#### High Efficiency

- **Energy conservation**  
Through saving energy we ensure future generations have a bright future, and save energy costs. KNX is at the forefront of energy saving. Be it shading, louver, room temperature controller, window sensor or light sensor, all can interconnect through KNX. The network can automatically reduce energy consumption, and heat consumption, making you achieve better power consumption rates.
- **Next-generation technology**  
A house can last a lifetime without being outdated. With KNX even though new generation devices will most likely supersede the old, the actual KNX system will remain. The system will help adapt your residence automation system, to meet your ever-changing demands. In doing so it may increase the long-term value of your property, and reduce the expense of upgrading in the future.
- **Customized**  
KNX is considered more than just an automation solution. We prefer to call it a modular system technology, and it has some prominent advantages. From being able to extend the network of automation at anytime, from small or large projects to rebuilt or newly built buildings, KNX always has the best customized products to ensure the most effective solutions.

#### Comfort

- **Daily life**  
With KNX you don't have to waste your valuable time on daily chores, regard KNX as your reliable assistant. Simply tell the system what is to be monitored and controlled, and the intelligent residence automation system will manage the remaining tasks and automatically notify you with the results.
- **Customized comfort**  
At night, you only need to press a button to get perfect light settings in your living room. When inviting guests, you can set the background light and music according to the occasion.
- **Automated management**  
Automatic blinds that adjust depending on room light intensity give a seamless and elegant solution to end users, when coupled with a centralised lighting control simplicity is guaranteed.
- **Overall management**  
One central information panel is utilized.

#### Promising Investment

- **Value-preserved system**  
KNX is the unique residence automation system that complies with the requirements of European (EN50090) and international (ISO/IEC 14543) standards. Its consistency confirms the quality and value of KNX technology. It provides quality assurance for owners. KNX is an open and extensible system easily used by users. It is ready set to provide new-generation products.
- **Open system**  
KNX lets you select from over 200 device manufacturers that provide various KNX-certified and compatible products. From this immense range you can select the product that best applies to your solution.

- **The demands of tomorrow**  
The future is unknown but KNX guarantees an independent future. Old age, infirmity or disability hamper independence. KNX makes household tasks obstacle and problem free, with the ability to integrate emergency buttons or house monitoring safety can be assured.





## Elevator Lights



## KNX Applications

- Lobbies / Public corridors / Elevator halls
- Clubs
- Offices
- Convention Centers
- Meeting rooms / Multi-function Halls / Banquet Halls
- Museums
- WCs/ Bathrooms / Dressing rooms
- Stadiums
- Garage or parking lots
- Schools
- Outdoor landscape Lighting
- Hospitals
- Malls
- Subways / Stations
- Airports

### Main Control Targets

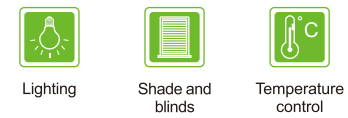

### Main Control Mode

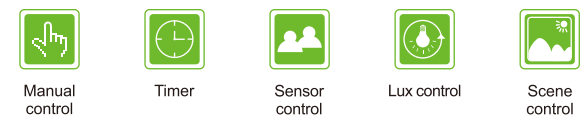

- To trigger pre-set scenes such as the welcome scene, daytime scene, or night scene, simply activate them with one touch. There is no need to repeatedly program the system to perform the same action.
- From adjusting lighting, and HVAC, to raising and lowering curtains and blinds the intelligent control panel or touch screen covers all areas and situations.
- The lighting/air conditioning is activated when the room is occupied, when the room detects it is vacant it is able to turn off part or all of the system depending on the programming.
- This ability is enabled through the use of displacement induction control, and timing control. As an example, when the system detects people lights are turned on, when it detects the room is vacant they are turned off.
- The system is also able to automatically control the lighting based on the amount of natural light present. In doing so energy conservation is maximised, and electrical costs are reduced.
- During the summertime, the system will regulate the sunshades automatically. This blocks the solar irradiation and keeps the indoor temperature relatively low, in winter the system works to increase the indoor temperature to reduce heating costs and energy consumption.





## Offices

## Meeting Rooms, Multi-Function Halls, Banquet Halls



### Main Control Targets



### Main Control Modes



- When displacement induction is triggered in the office space the lighting is automatically turned on, and the welcome mode is activated.
- Through the intelligent panel or remote control the lighting can be turned on/off, the brightness adjusted, blind angle manipulated, and scenes chosen. Common scenes for offices include meeting mode, rest mode, and working mode.
- While the intelligent panel or remote control can manage the environment, automatic control of the indoor lighting, curtains, and temperature ensures a hassle free office atmosphere.

### Main Control Targets

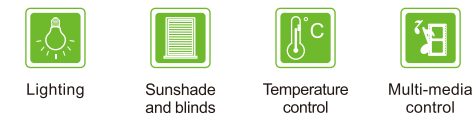

### Main Control Modes



- The control of lighting, air conditioning, curtains and projection equipment can all be accomplished from one intelligent panel. Via the intelligent panel various scenes can be enabled, common scenes include meeting, banquet, speech, and rest.
- With an intelligent panel it is possible to partition a room into several areas. The lighting, curtains, and air conditioning can be controlled via area, or as a group of areas. This level of convenience and control gives the user a unique experience and tailors the environment to their specifications.
- Cost saving is also assured through the use of sensors that activate the lighting and air conditioning automatically when a person enters. When the room is empty lighting and A/C is deactivated.



## WCs/Bathrooms / Dressing Rooms

## Garage or Parking Lots

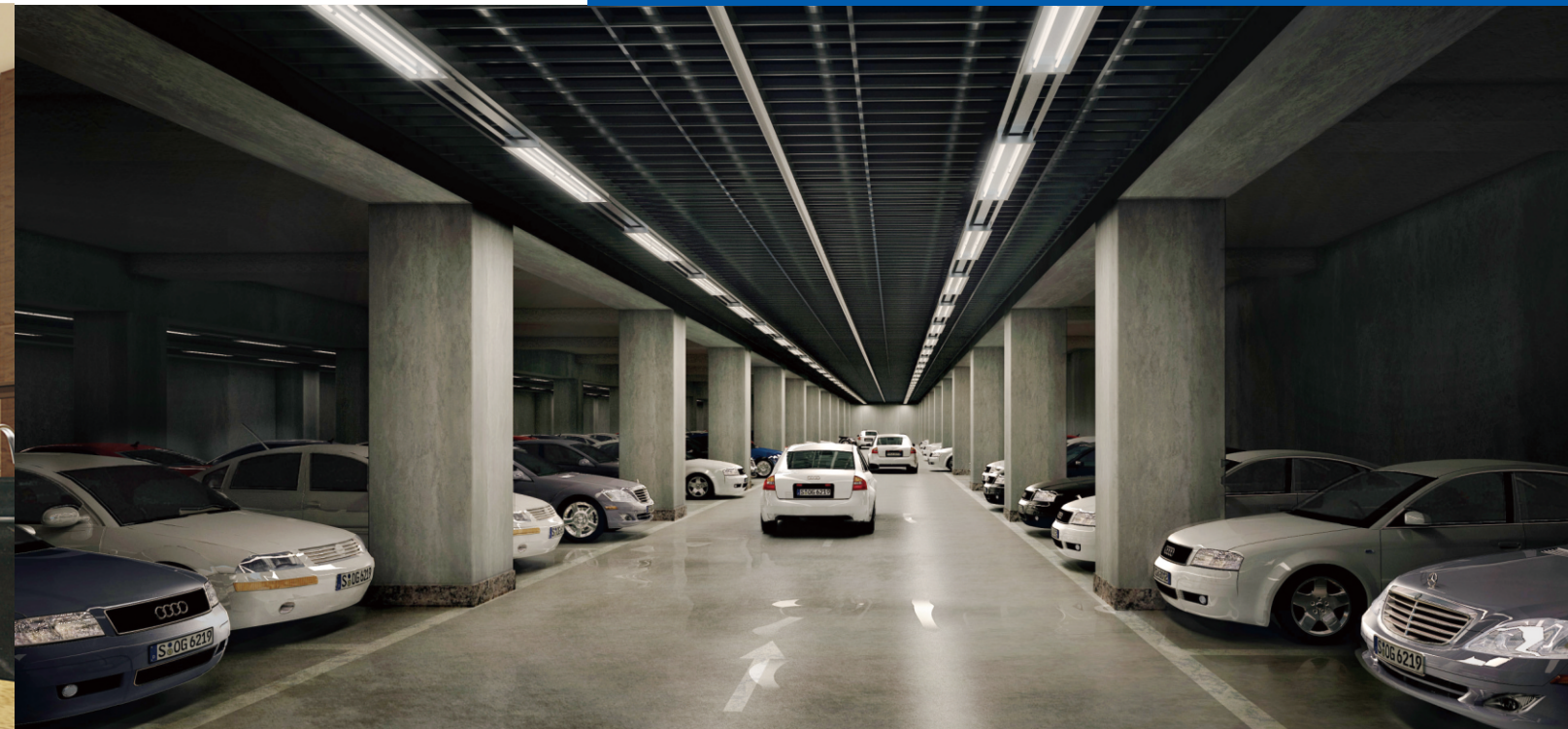

### Main Control Targets



### Main Control Modes



- Automatically activate the lighting, air conditioning, and exhaust fan when the room is occupied. When the room becomes vacant the lights, A/C and exhaust fan will deactivate automatically.
- The exhaust fan also has the ability to be intermittently activated during the night.

### Main Control Targets



### Main Control Modes

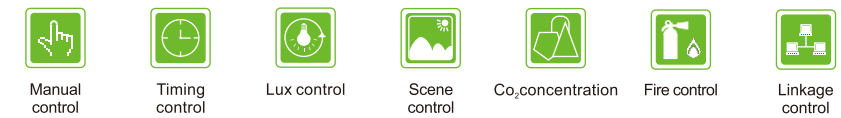

- Turn on different lighting modes based on area division through manual control, timing control, and remote centralized control from the intelligent panel.
- The lighting can be turned on in one specific area if the luminosity sensor detects a low light reading. This application is especially useful in large installations where varied weather conditions may cause insufficient natural illumination.
- Automatic control of fans and exhaust fans can provide the optimum environmental conditions for underground garages.
- When the system detects carbon dioxide via its air quality sensor, the relevant exhaust fan will automatically remove the gas from the area.
- Emergency lighting serves a dual role as normal lighting, the lighting can also be interlinked to the firefighting system in case of emergency.
- Linkage control with the parking management system allows vehicles to follow lane guidance lights to their designated parking space.



## Outdoor Landscape Lighting

## Malls



### Main Control Targets



### Main Control Mode



- Manage outdoor lighting seamlessly with full manual control, alternatively use an intelligent panel or touch screen for remote control.
- Turn on outdoor floodlighting at a fixed time or use a remote control, when night falls turn off non-essential circuits.
- Holistically control water circulation, soil moisture, sprinklers, fountains and landscape lighting through integrating with their system management programmes. Through this centralised control, scenes can be created that exemplify architectural style, landscapes or seasons.
- Scenes can be activated with a simple one-key switch and can be changed instantly. This immense level of management provides optimum control and energy savings.

### Main Control Targets



### Main Control Modes



- Different lighting and HVAC parameters can be established to meet the needs and functions of different areas.
- Scenes can be established in different areas and at different times. Common scenes for malls are, opening mode, business mode, clearing mode, and security mode.
- Different seasons demand different control modes, for example in summer, sunshades and illumination sensors are necessary to reduce air conditioning load. During the winter sunlight must be allowed into the building in order to reduce illumination and heating costs.
- If a system failure does occur a manual/auto switch is included to ensure normal operations can be accomplished.
- Energy measurement is used to ensure proficient energy distribution, this can give huge energy savings and increase operational efficiency.



## Airports



### Main Control Targets

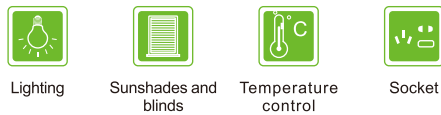

### Main Control Modes



- All lighting, sunshades, air conditioners, sunroofs, power sockets, can be accessed from in the inward and outward port hall, or from the waiting hall.
- Different lighting scenes can be set in the waiting hall, these scenes can have separated time periods and activate the air conditioning in different areas.
- The sunshades can be automatically adjusted through illumination induction, this reduces energy consumption and increases the efficiency of air conditioners and lighting.
- Light damage can be estimated through current detection, this gives maintenance crews advanced warning so they can save costs and remedy the situation.
- A sensor that monitors weather conditions is able to control skylights and ventilating blinds, this guarantees efficient air circulation.
- Fire protection systems are linked to the lighting in public areas to ensure effective emergency lighting.

## Clubs



### Main Control Targets

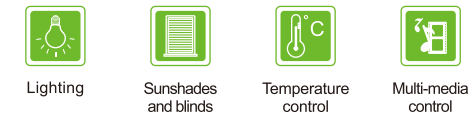

### Main Control Modes



- Differing atmospheres can be created by altering the lighting scenes. Different scenes can be set to match different scenarios, popular scenes include relaxed, party, dinner, wedding, meeting, etc.
- The lighting, curtains, air conditioners, and background music can be controlled via an intelligent control panel, a remote controller, or an android/iOS device.
- Any blinds or curtains can be automatically adjusted based on seasonal information, or sensor input. This can reduce energy consumption, and increase the efficiency of air conditioners and lighting.
- Complete control of a clubs environment is possible by utilizing a single member of staff to monitor the control interface.



## Exhibition Centers

## Museums



### Main Control Targets



### Main Control Modes



- Different scenes can be set during the exhibition, from move In mode, exhibition mode, and move out mode, etc.
- Different scenes can be set in the exhibition hall at different time periods, air conditioning can also be set at different levels for different areas.
- Exhibition spaces can be partitioned with localised lighting and HVAC control. Lighting can also be reconfigured to meet the needs of exhibitors.
- Electrical shading devices can be regulated automatically via a luminance transducer, this dramatically reduces the energy consumption of air conditioners.
- Fire protection systems are linked to the lighting in public areas to ensure effective emergency lighting.

### Main Control Targets



### Main Control Modes

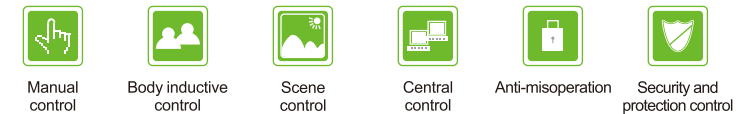

- All lighting devices in the museum are managed through a central control system, this system can be manipulated via intelligent control panels and inductive controls. Different scenes can be set during the museums preparation period, operational period, cleaning period and closing period.
- In the exhibition areas switches control only the basic lighting, they are automatically activated via displacement induction when visitors or staff are detected.
- Illumination in the major exhibition areas is activated when a display is approached, when the display is not being viewed the lights are deactivated.
- In special exhibition areas intelligent control panels manage the lighting effects. When the panels are in operation they are locked to prevent tampering, after the public have left the panel is unlocked enabling staff to control the system.
- Temperature is controlled according to the different requirements of individual areas. From exhibition areas, rest areas, passageways, and storage areas the temperature can be adjusted. This provides a suitable temperature for visitors, and ensures areas of low use do not waste electrical resources.
- The system can also be interlinked to the security control system. This gives additional security, and enables an alarm to be raised if there is an emergency situation.



## Stadiums

## Schools



### Main Control Targets

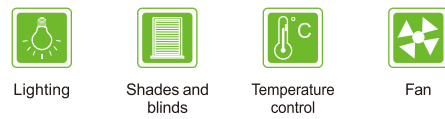

### Main Control Mode



- Various modes can be switched to using an intelligent panel, from TV broadcast mode, game mode, training mode, cleaning mode, security mode, etc.
- The real time monitoring of system status is available which notifies the user if any fault is detected.
- Device status can be monitored, and statistics delivered. This makes the system simple to manage, and saves on maintenance costs.
- Fire prevention devices are able to interlink and coordinate with the system, the general lighting can be dimmed and emergency lighting activated.
- The system is able to control lighting, electrical shading, drainage pumps, and ventilation all through one central hub.

### Main Control Targets



### Main Control Mode

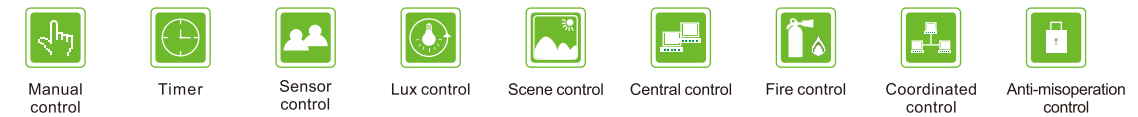

- Each classroom can have the lighting, fans, and air conditioning managed via a customisable schedule. Different modes can be used for different times, common modes are weekdays, weekends, holidays, and special events.
- Intelligent panels can control the lights, curtains, air conditioning and projectors. Different modes can be selected or programmed via the panel itself.
- Through sensors the lights and air conditioning can be automatically activated when a presence is detected. The lights can be dimmed or brightened depending on the amount of natural light present.
- The entire school can be managed centrally, and graphical management software can be used to detect the status of each device. This ensures immediate notification when a failure occurs, enabling swift maintenance and saving manpower.
- Every panel can be locked by an administrator to prevent and avoid tampering.



## Hospitals

## Subway Stations



### Main Control Targets



### Main Control Mode

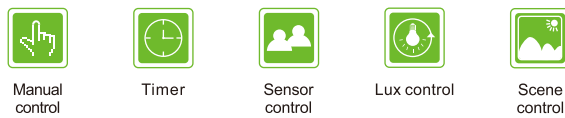

- Intelligent panels can control lights, curtains, air conditioning, and activate different modes such as consultation mode or rest mode.
- The nurse's station can control lighting, curtains, and air conditioning. The temperature of the ward can also be monitored, this ensures an optimal environment for the patient.
- Corridor lighting can be activated automatically by Lux and logic control, dome lights can be automatically turned off at midnight.
- Administrators can remotely control the system and operate ward lights, curtains, and air conditioning when a patient checks in. After checkout an administrator can automatically or manually manage the ward.
- The system is able to display and control the temperature of each ward and set upper and lower temperature limits from a central control station. If a door or window is detected as being open, the air conditioner will automatically deactivate to ensure energy is not wasted.

### Main Control Targets

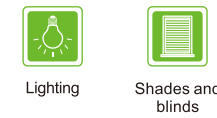

### Main Control Mode

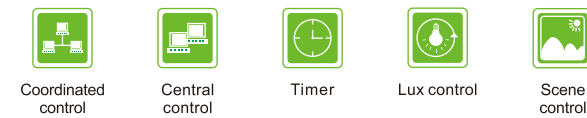

- The system is able to coordinate with Lux sensors, and timing controls. This enables the user to remotely manage the platform or waiting room.
- Different control modes can be used for different seasons, this provides a tailored response to varying environmental conditions.
- Fire prevention devices are able to coordinate with the system, the general lighting can be dimmed and emergency lighting activated when an alarm is tripped.
- The status of lighting, curtains, blinds, and fans can be observed via graphical management software. This can be manually configured on site to achieve efficient command and control.



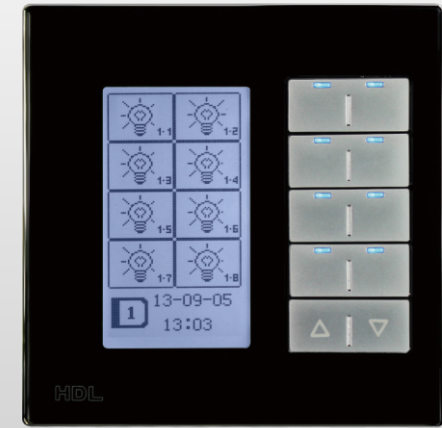

KNX-DLP Intelligent Multifunction Panel To European Standard

M/DLP04.1-48

HDL-KNX PRODUCTS

- KNX-DLP European / American standard intelligence multifunction panel
- KNX European / American standard intelligence panel
- KNX European / American standard intelligence panel
- KNX Intelligence panel
- KNX European / American standard touch panel
- KNX Panel Controller-C
- KNX Relay Actuator
- KNX Dimming Actuator
- KNX Motor Curtain 1CH Actuator
- KNX RGBW 4 fold Driver
- KNX Outdoor Doppler Sensor
- KNX Indoor Doppler Sensor
- KNX Ultrasonic & Motion Sensor
- KNX Motion Sensor
- KNX USB Interface
- KNX Curtain Module
- KNX HVAC Module
- KNX Dry contact Module
- KNX DMX512 Recorder
- KNX Infrared Emission Module
- KNX 960mA Power supply
- KNX 4 Core Cable
- KNX Line Coupler/Repeater



Material and color are customizable

The plate and button material can be customized to meet different design styles.

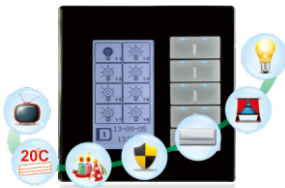

Multipurpose

With a total of 6 pages, 3 pages can be used for lighting, 1 page for HVAC, 1 page for AC, and 1 page for Floor Heating.

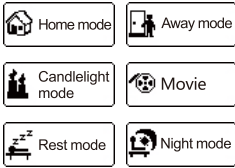

DIY personalized labels

Users can define their own button icons with the HDL-KNX Assistant Software.



Lock

Users can lock the LCD panel by the onboard buttons or by the Bus.

Specifications

- Working voltage: 21-30V DC
- Dynamic current: <17mA
- BUS Interface: KNX / EIB
- Static current: <13 mA

Combination support

- Work with M/IRAC.1 infrared module for IR control
- Work with M/FCUO1.10.1 HVAC module for HVAC/Floor heating control

Features

- Switch control
- Percentage control
- HVAC Control
- Dimming control
- Combination control
- Button Lock
- Shutter control
- Bytes(String) control
- Button Trigger
- Flexible control
- Backlight brightness settings
- Remote control
- Scene control
- Floor heating control
- Temperature Report
- Sequence control
- IR Control
- Night mode setting
- Threshold control





## KNX European Standard Intelligence Panel

M/P01.2-48 | M/P02.2-48 | M/P03.2-48 | M/P04.2-48

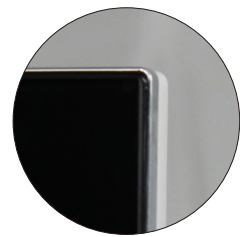

### Unique and elegant

The product is characterized by a metal frame with glass plating, this is consistent with new design trends.

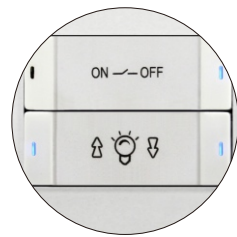

### LED indicator

It is equipped with an LED button status indicator that allows you to properly monitor the device.

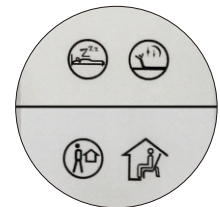

### DIY personalized labels

Users can define their own button icons.

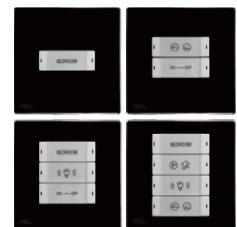

### Variety of keypad types

There are four types of keypads to choose from, they have 1,2,3,4 keys respectively.

## Specifications

- Working voltage: 21-30V DC
- BUS Interface: KNX/EIB
- Dynamic current: <10mA
- Static current: <6mA

## Features

- Switch control
- Percentage control
- Button Trigger
- Dimming control
- Threshold control
- Remote control
- Shutter control
- Combination control
- Night mode setting
- Flexible control
- Bytes(String) control
- Independent control
- Scene control
- Button lock
- Key combination control
- Sequence control
- Backlight brightness settings

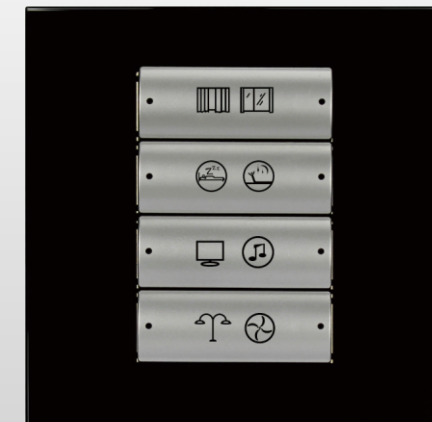

## KNX European Standard Intelligence Panel

M/P02.1-38 | M/P04.1-38



### Unique and elegant

With a single glass plate, the layout is more concise, this highlights the elegant style of the unit.



### DIY personalized label

Laser engraving technology with back light effect makes your panel look unique.

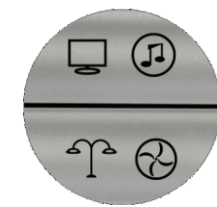

### Large buttons, LED indication

A large button design ensures simple use, an LED button status indicator allows you to check the device status.



### Variety of key types

There are two types of keypad, choose from 2 or 4 key combinations that meet a multitude of needs.

## Specifications

- Working voltage: 21-30V DC
- BUS Interface: KNX/EIB
- Power consumption: <10mA

## Features

- Switch control
- Percentage control
- Button Lock
- Dimming control
- Threshold control
- Button Trigger
- Shutter control
- Combination control
- Remote control
- Flexible control
- Bytes(String) control
- Night mode setting
- Scene control
- Backlight brightness settings
- Sequence control



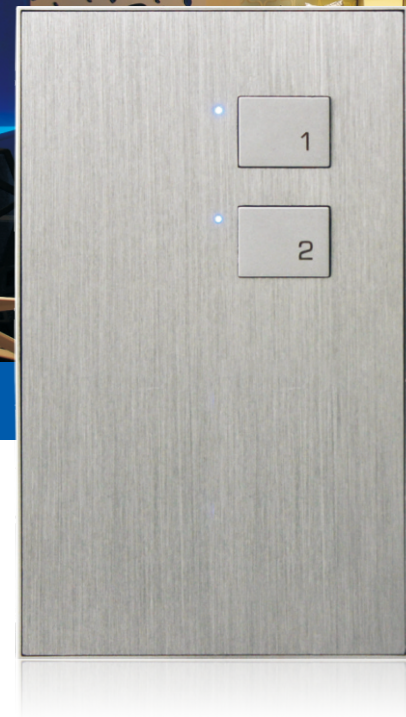

### KNX Intelligence Panel

M/P01.3 | M/P02.3 | M/P04.3



**LED indication**  
Equipped with LED button status indicators, you can easily check the device status.



**Unique and elegant**  
With a timeless brushed aluminum housing, the unit is sleek and built to last.



**A variety of key types**  
With a choice of three keypads and 2, 4, or 8 keys you can choose the solution that best meets your needs.

### Specifications

- Working voltage: 21-30V DC
- BUS Interface: KNX/EIB
- Dynamic current: <10mA
- Static current: <6mA

### Features

- Switch control
- Sequence control
- Bytes(String) control
- Dimming control
- Percentage control
- Night mode setting
- Shutter control
- Threshold control
- Independent control
- Flexible control
- Combination control
- Key combination control
- Scene control
- Backlight brightness settings



### KNX European Standard Touch Panel

M/TBP1.1-48 | M/TBP2.1-48 | M/TBP3.1-48 | M/TBP4.1-48



**A touch button illuminated display with replaceable plate and frame**  
The buttons support RGB colors, and are ergonomic and easy to use.



**DIY personalized labels**  
Different colors and patterns are available for the fascia, this enables them to blend seamlessly into a multitude of environments.



**A variety of choices for key types**  
Four keypad types are available with 1, 2, 3, or 4 buttons to choose from.

### Specifications

- Working voltage: 21-30V DC
- BUS Interface: KNX/EIB
- Dynamic current: <12mA
- Static current: <7mA

### Features

- Switch control
- Sequence control
- Bytes(String) control
- Dimming control
- Percentage control
- Button lock
- Shutter control
- Threshold control
- Button trigger
- Flexible control
- Combination control
- Scene control
- Backlight brightness settings



# KNX-DLP Multifunctional LCD Switch US

M/DLP04.1-46

M/DLP04.1-46 / Black glass

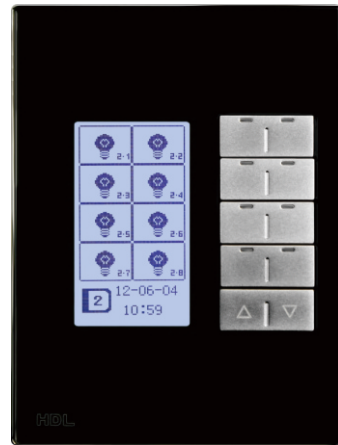

M/DLP04.1-46 / White glass



- Metal buttons
- Electronic labels
- Selectable plate and frame

## Specifications

- Working voltage: 21-30V DC
- BUS interface : KNX/EIB
- Dynamic current: <17mA
- Static current: <13mA

## Features

- Switch control
- Percentage control
- HVAC control
- Dimming control
- Combination control
- Button lock
- Shutter control
- Bytes(String) control
- Button trigger
- Flexible control
- Backlight brightness settings
- Remote control
- Scene control
- Floor heating control
- Temperature report
- Sequence control
- IR control
- Night mode setting
- Threshold control

## Combination support

- Works with M/IRAC.1 infrared emission modules for IR control
- Works with M/FCUO1.10.1 HVAC modules for HVAC/Floor heating control

## Multiple Control Pages



- Lighting
- HVAC
- Floor Heating
- Air Condition

■ Note: Built-in IR receiver, the plate needs an IR receiving hole to accommodate IR functionality.

# KNX Multifunctional Switch US

M/P01.2-46 | M/P02.2-46 | M/P03.2-46 | M/P04.2-46

M/P01.2-46



## Specifications

- Working voltage: 21-30V DC
- BUS interface : KNX/EIB
- Dynamic current: <10mA
- Static current: <6mA

## Features

- Switch control
- Percentage control
- Button Trigger
- Dimming control
- Threshold control
- Remote control
- Shutter control
- Combination control
- Night mode setting
- Flexible control
- Bytes(String) control
- Independent control
- Scene control
- Button Lock
- Key combination control
- Sequence control
- Backlight brightness settings

## Fascia color and style is customizable



- White/8 Buttons
- White/6 Buttons
- White/4 Buttons
- White/2 Buttons

■ Note: Built-in IR receiver, the plate needs an IR receiving hole to accommodate IR functionality.

M/P02.2-46

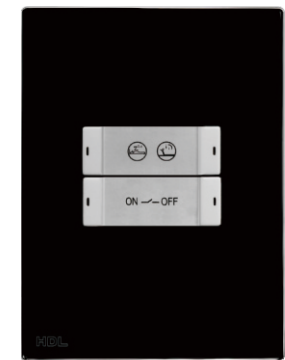

M/P03.2-46



M/P04.2-46





## KNX Multifunction Switch

M/P02.1-46 | M/P04.1-46

M/P02.1-46



M/P04.1-46

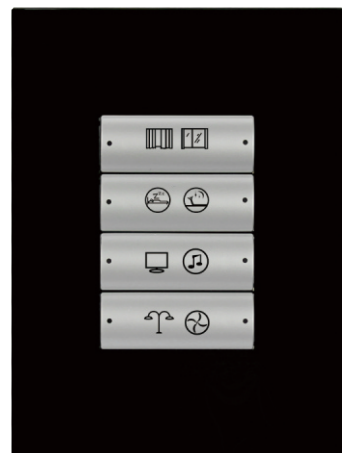

### Specifications

- Working voltage: 21-30V DC
- BUS interface: KNX/EIB
- Current consumption: <20mA

### Features

- Switch control
- Dimming control
- Shutter control
- Flexible control
- Scene control
- Sequence control
- Percentage control
- Threshold control
- Combination control
- String control
- Key lock
- Button trigger
- Backlight brightness setting
- Night mode setting

### Fascia color and buttons are customizable

- Note: Built-in IR receiver, the plate needs an IR receiving hole to accommodate IR functionality.

## KNX Touch switch US

M/TBP2.1-46 | M/TBP4.1-46 | M/TBP6.1-46

### Specifications

- Working voltage: 21-30V DC
- BUS interface: KNX/EIB
- Dynamic current: <12mA
- Static current: <7mA

### Features

- Switch control
- Sequence control
- Bytes(String) control
- Dimming control
- Percentage control
- Button lock
- Shutter control
- Threshold control
- Button trigger
- Flexible control
- Combination control
- Scene control
- Backlight brightness settings

### Supports RGB Back-light Fascia color and style is customizable



- White/2 Buttons
- White/4 Buttons
- White/6 Buttons

M/TBP2.1-46

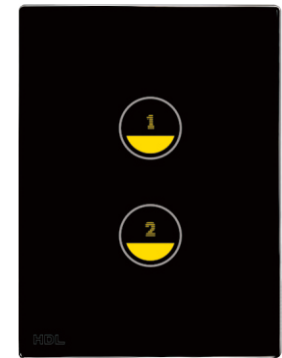

M/TBP4.1-46

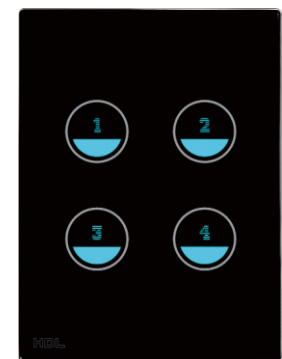

M/TBP6.1-46

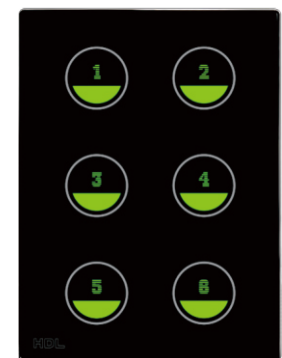



## KNX Panel Controller-C NEW PRODUCT

M/P01.2-C1 | M/P02.2-C2 | M/P02.2-C3 | M/P02.2-C4 | M/P03.2-C5 | M/P03.2-C6

M/P01.2-C1



■ Panel 1 Rocker Controller-PV2(V1.2)

M/P02.2-C2 | M/P02.2-C3 | M/P02.2-C4



■ Panel 2 Rocker Controller-PV2(V1.2)

M/P03.2-C | M/P03.2-C6



■ Panel 3 Rocker Controller-PV2(V1.2)

### Specifications

- Working Voltage: 21~30VDC
- Bus interface: KNX/EIB
- Static current: < 9mA
- Dynamic current: < 16mA

### Features

- Each rocker has 2 work modes: Combined button mode and independent button mode.
- It supports kinds of data point and function, include Switch control, Dimming, Shutter control, Flexible control, Scene control, Sequence control, Percentage control, Threshold control, Combination control, String(14bytes) controller, pulse controller.
- Button Lock, Button Trigger.
- Keep pressing the first and last button together for 2 seconds, the LED Indicators will flashing and the device enter programming mode.
- User can define button icon.

HDL KNX / EIB multifunction Panel controller include many kind of data point, can be used for many applications like lighting dimming, switch, curtain etc.

## KNX Motor Curtain 1CH Actuator NEW PRODUCT

M/WM70M.1

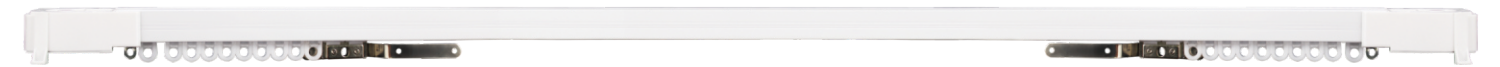

### Specifications

- Program name: Motor Curtain 1CH Actuator
- Bus interface: KNX/EIB (Master)
- Model NO.: M/WM70M.1 (Master) M/WM70S.1 (Slave)
- Rated voltage: AC220V 50Hz
- Voltage range: AC220V±20% 50HZ
- Working voltage: DC21 -30V(Master) DC12V(Slave) from Master
- Bus power Consumption: <10mA/DC30V (Master)
- Slave interface: 6P network port
- Rated power: 70W
- Rated torque: 1.0Nm
- Rated speed: 112rpm
- Rail belt speed: 16cm/s

### Features

- Standard control (with percentage)
- Simple control (without percentage)
- Automatic measure distance.
- Manual mode: Long drag, short drag.
- Can control to open, close, stop and percentage.
- Can respond the status (open, close, stop, percentage, limited position, etc.)
- Has status after bus voltage recovery function.
- Safety control. Control the curtain position by wind, rain, frost signal
- Auto control. Control the curtain position by sun/ no sun, heating, cooling signal
- Scene control
- Forced operation
- Trigger control
- Save status before power off function



MASTER

SLAVE

M/WM70M.1

M/WM70S.1



MASTER



SLAVE



## KNX Relay Series

M/R4.16.1 | M/R8.16.1 | M/R12.16.1 | M/R16.16.1

HDL / KNX-EIB BUS relay series products are fully compliant with European safety standards and protocols for High-power KNX switching equipment. With almost zero power consumption, and 50A High-current magnetic relays, the unit ensures a long service life. Being widely used in airports, metro stations, stadiums, parks, roads, and studios KNX products have proven themselves to be reliable and efficient.

M/R4.16.1 | 4CH\*16A



- Output channel : 4 relays channel

M/R8.16.1 | 8CH\*16A



- Output channel : 8 relays channel

M/R12.16.1 | 12CH\*16A



- Output channel : 12 relays channel

M/R16.16.1 | 16CH\*16A



- Output channel : 16 relays channel

### Specifications

- Working voltage : 21-30V DC
- BUS interface: KNX/EIB
- Dynamic current: <15mA
- Static current: <5mA
- Dynamic power consumption : <450mW
- Static power consumption : <150mW
- Output current: 16A
- Rated voltage : 250V AC(50/60Hz)
- Electrical life : >100000 times
- Mechanical life : >1000000 times

### Features

- Time statistics function
- Channel status response
- On/Off status can set on power failure
- Staircase light
- Flashing
- On/Off/Protection delay
- Scene control
- Threshold function
- Curtain control function
- Logic function: And, Or, Xor, Gate
- Heating function: PWM control output

## KNX Relay Series

M/R4.10.1 | M/R8.10.1 | M/R12.10.1 | M/R16.10.1

HDL provides solutions for smart homes and building control, our systems enable the world to save energy, and protect the environment.

In doing so we provide comfort, convenience and a higher living standard.

### Specifications

- Working voltage:21-30V DC
- BUS interface: KNX/EIB
- Dynamic current: <15mA
- Static current: <5mA
- Dynamic power consumption : <450mW
- Static power consumption : <150mW
- Output current: 10A
- Rated current : 250V AC(50/60Hz)
- Electrical life : >100000 times
- Mechanical life : >1000000 times

### Features

- Time statistics function
- Channel status response
- On/Off status can set on power failure
- Staircase light
- Flashing
- On/Off/Protection delay
- Scene control
- Threshold function
- Curtain control function
- Logic function: And, Or, Xor, Gate
- Heating function: PWM control output

M/R4.10.1 | 4CH\*10A



- Output channel: 4 relays channel

M/R8.10.1 | 8CH\*10A



- Output channel: 8 relays channel

M/R12.10.1 | 12CH\*10A



- Output channel: 12 relays channel

M/R16.10.1 | 16CH\*10A



- Output channel: 16 relays channel



## KNX Dimmer Series

M/D01.1 | M/D02.1 | M/D04.1 | M/D06.1

The HDL KNX/EIB series of Leading Edge/Trailing Edge Dimmers fully comply with both the European safety standards and KNX protocol standards.

Chopper 20A MOSFET dimming technology is used, coupled with a high performance embedded EMC filter. The dimmers all have short circuit protection, over load protection, and over Heat protection. They can be used for the dimming of ordinary incandescent lamps, high pressure halogen lamps, low voltage halogen lamps, other light sources, and dimmable ballasts.

KNX/EIB Dimmers can be used in variety applications from Homes, Hotels, Super Markets, offices to airports and stadiums.

HDL provides solutions for smart homes and building control, our systems enable the world to save energy, and protect the environment.

In doing so we provide comfort, convenience and a higher living standard.

### M/D01.1 | 1CH\*6A



- Output current : 6A/1CH

### M/D02.1 | 2CH\*3A



- Output current : 3A/1CH
- Signal channel maximum output voltage : 3.5A

### M/D04.1 | 4CH\*1.5A



- Output current : 1.5A/1CH
- Signal channel maximum output voltage : 2A

### M/D06.1 | 6CH\*1A



- Output current : 1A/1CH
- Signal channel maximum output voltage : 1.5A

## Specifications

- Working voltage : 21-30V DC
- BUS interface: KNX/EIB
- Dynamic current: <12mA
- Static current: <7mA
- Allow total power : ≤6A
- Extended current: Parallel circuit
- Load type: Capacitive load, inductive load, resistive load
- Dimming mode: Leading edge dimming, trailing edge dimming
- Rated voltage : 220V/110V AC(50/60Hz).

## Features

- Time statistics function
- Status response
- Status recovery
- Short circuit protection
- Overload protection
- Overheat protection
- Staircase light
- Flash light
- Scene control
- Temperature reading
- High temperature alarm
- Over temperature power reduce
- Dimming higher limit
- Dimming lower limit
- Sequence control
- Threshold switch
- Heating control (PWM)
- 1.5 power dimming curve (very smooth visual sense)

## KNX Dimmer Series

### KNX Ballast Dimmer 6CH 0-10V

M/DA6.10.1

## Specifications

- Working voltage : 21-30V DC
- BUS interface: KNX/EIB
- Dynamic current: <15mA
- Static current: <5mA
- Shut down way : Pulsed with the lock relay shut off
- Rated Voltage : 220~250V AC(50/60Hz)
- Analogue dimming : 0-10v
- Output current: 10A/1CH
- Output channel : 6 channel

## Features

- Time statistics function
- Status response
- Status recovery
- Staircase light
- Flash light
- Scene control
- Dimming higher limit
- Dimming lower limit
- Sequence control
- Threshold control
- Heating control(PWM)

### KNX Leading Edge Dimmer Serials

M/DL02.1 | M/DL04.1 | M/DL06.1

The HDL KNX/EIB Leading Edge Dimmers fully comply with European safety standards and KNX protocol standards. The 25A TRIAC is used for the M/DL02.1 and M/DL04.1, while the 16A TRIAC used for M/DL06.1. This dimmer series has short circuit, over load protection, and over heat protection.

## Specifications

- Working voltage : 21-30V DC
- BUS interface: KNX/EIB
- Dynamic current: <12mA
- Static current: <7mA
- Maximum current : ≤6A
- Dimming mode : Leading Edge Dimming
- Dimming curve : 1.5 power dimming curve
- Rated voltage: 220V/110V±20%
- Frequency: 50/60Hz

## Features

- Time statistics function
- Staircase light
- Status response
- Status recovery
- Short circuit fuse protection
- Overload fuse protection
- Overheat power reduce
- Flash light
- Scene control
- Temperature Reading
- High temperature
- Over temperature alarm
- Dimming higher limit
- Dimming lower limit
- Sequence control
- Threshold switch
- Heating control (PWM)
- 1.5 power dimming curve
- Very smooth visual sense

### M/DA6.10.1 | 6CH\*10V



- The HDL KNX / EIB dimmers can control from 0v to 10v per channel.
- The output channels have a maximum amperage of 10A per channel, they can control both inputs and outputs. Because of this absorption and output type ballasts can be utilized.

### M/DL02.1 | 2CH\*6A



- Output channel : 2CH/6A ; Fuse : 10A aR type;
- Silicon controlled : 25A TRIAC , Minimum Load 40w

### M/DL04.1 | 4CH\*3A



- Output channel : 4CH/3A ; Fuse : 8A aR type;
- Silicon controlled : 25A TRIAC, Minimum Load 40w

### M/DL06.1 | 6CH\*2A



- Output channel : 6CH/2A ; Fuse : 4A aR type;
- Silicon controlled : 16A TRIAC, Minimum Load 30w



## KNX Curtain Controller Series

M/W02.10.1 | M/W04.10.1 | M/W06.10.1

The HDL / KNX-EIB Curtain controller fully abides to European safety standards. Using a 10A magnetic current, this series offers power free functionality and high reliability.

The curtain controller can be installed in airports, metro stations, sports stadiums, buildings, clubs, hospital wards, or other areas where curtain control is required.

Our company specializes in developing, manufacturing and distributing Home/building automation systems and stage lighting control systems. We provide green solutions that are environmentally friendly, conserve energy, and ensure a high quality of life.

### M/W02.10.1 | 2CH



- Output channel : 4 Relay /2 channel

### M/W04.10.1 | 4CH



- Output channel : 8 Relay /4 channel

### M/W06.10.1 | 6CH



- Output channel : 12Relay/6Channel

## Specifications

- Working voltage : 21-30V DC
- BUS interface: KNX/EIB
- Static power consumption : <150mW
- Output current : 10A
- Dynamic current: <12mA
- Static current: <5mA
- Dynamic power consumption : <450mW
- Rated current : 250V AC(50/60Hz)
- Electrical life : >100000 times
- Mechanical life : >1000000 times

## Features

- Shutter mode
- Ordinary curtains mode
- Limit position control
- Position status response
- Power down status save
- Power on status recovery
- Manual operation
- Priority setting
- Operation status response
- Scene control
- Force position operation
- Safety control
- Automatic control

## KNX RGBW 4 fold Driver **NEW PRODUCT**

M/DRGBW4.1

## Specifications

- Bus interface: KNX/EIB
- Working voltage: DC21 -30V(Master)
- Bus power Consumption: <10mA/DC30V
- Output: R, G, B,W 4channels, 4A/CH
- Output type: common anode RGBW LED strip and single LED
- Housing material: ABS , PC , ALU
- Dimensions:183.5×75×35.5(mm)

## Features

- Dimming function: relative dimming and absolute dimming
- Sequence, total 5 sequences. Each sequence has 24steps.
- Staircase light
- Flashing light
- Scene, total 64 scenes.
- Logic
- Threshold
- Custom on/off \*
- Color selection \*

\* only for combination RGBW channel.

### M/DRGBW4.1

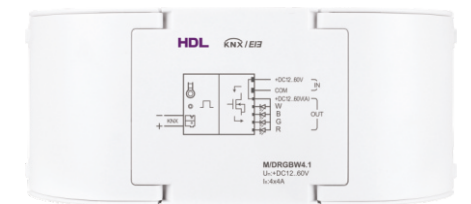



## KNX Outdoor Doppler Sensor **NEW PRODUCT**

M/WS05.1-A



### Specifications

Working power: 21~30VDC
BUS interface: KNX/EIB
Dynamic current: < 24mA
Static current: < 20mA
Temperature detection range: -30°C~70°C
Illumination detection range:0~15000LUX
Humidity detection range:20~95% RH
KNX terminals:(Red /Black) 0.75 – 0.85mm Diameter Single-Core

### Functions

Built-in LUX sensor, microwave sensor, humidity sensor,temperature sensor, dry contact, external telegram.
The multi-function motion sensor have 5 logic function blocks and can be set the logical relation AND/OR, Each with 10 output objects. The work mode include single mode and Master & Slave mode.
The multi-function motion sensor can report movement status, Lux status to KNX system.
The multi-function motion sensor supports constant brightness output.
It can controls for Switch control, Absolute dimming control,Shutter control, Alarm control, Percentage control , Sequence control, Scene control, String(14 bytes) control,Threshold control, Logic combination.
With function of constant brightness: keep the Lux in the constant value, will dim the lights to the corresponding intensity according to the surrounding brightness.
The logic validity can be set by external telegram, enable end-user to enable or disable the preset logics.

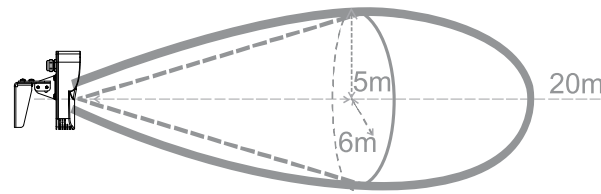

sensing range

## KNX Indoor Doppler Sensor **NEW PRODUCT**

M/WS05.1-B



### Electrical parameters

Working power :21~30VDC
BUS interface ;KNX/EIB
Dynamic current : < 20mA
Static current : < 16.5mA
Temperature detection range :-30°C~70°C
Illumination detection range :0~15000LUX
Humidity detection range :20~95%RH
KNX terminals:(Red /Black) 0.75 – 0.85mm/Diameter Single-Core

### Functions

Built-in LUX sensor, microwave sensor, humidity sensor,temperature sensor, dry contact, external telegram.
The multi-function motion sensor have 5 logic function blocks and can be set the logical relation AND/OR, Each with 10 output objects. The work mode include single mode and Master & Slave mode.
The multi-function motion sensor can report movement status, Lux status to KNX system.
The multi-function motion sensor supports constant brightness output.
It can controls for Switch control, Absolute dimming control,Shutter control, Alarm control, Percentage control , Sequence control, Scene control, String(14 bytes) control,Threshold control, Logic combination.
With function of constant brightness: keep the Lux in the constant value, will dim the lights to the corresponding intensity according to the surrounding brightness.
The logic validity can be set by external telegram, enable end-user to enable or disable the preset logics.

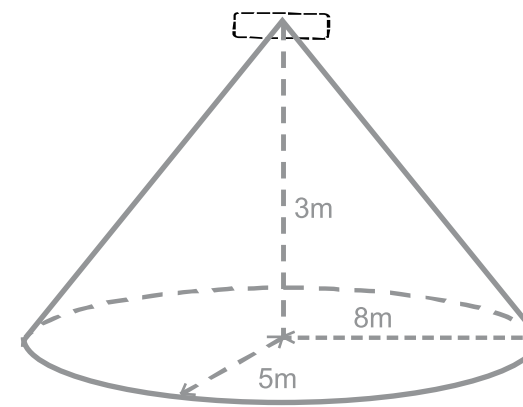

sensing range



## KNX Ultrasonic & Motion Sensor

M/HSIU05.1



### Specifications

- Working voltage: 21-30V DC
- Dynamic current: <15mA
- Static current: <6mA

### Logic Block input Conditions

- 6 different logic input conditions
- External conditions input
- Motion sensor
- Ultrasonic sensor
- LUX sensor
- Dry contact
- Temperature sensor
- Logic relations: AND, OR

### Features

- Switch control
- Percentage control
- Absolute Dimming
- Sequence control
- Shutter control
- Scene control
- Alarm control
- String control(14 bytes)

### Functions

- The HDL-HSIU05.1 multi-function sensor include ultrasonic, PIR, temperature, LUX and drycontact input.
- The sensor have 5 logic function blocks with logical relation AND/OR, Each with ten output objects.
- Master & Slave for many sensor to control one channel light.
- The sensor can report movement status, temperature, Lux or dry contacts status to KNX system.
- The recommend install on the wall, the height about 1.2 to 1.8m.
- Support many controls type: Switch control, Absolute dimming control, Shutter control, Alarm control, Percentage control, Sequence control, Scene control, String(14bytes) control, Threshold controller, Logic combination control.

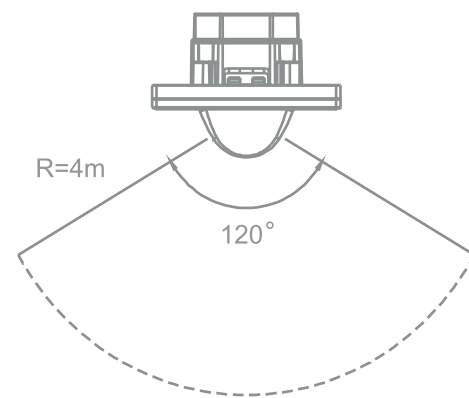

sensing range

## KNX Motion Sensor

M/HS05.1-B



### Specifications

- Working voltage: 21-30V DC
- BUS interface: KNX/EIB
- Dynamic current: <10mA
- Static current: <5mA

### Features

- Switch control
- Dry contact input
- Shutter control
- Dry contact status report
- Alarm control
- Temperature compensation
- Percentage control
- Temperature report
- Sequence control
- Lux control
- Absolute value dimming control
- Lux report
- Scene control
- Motions status report
- String control
- Multifunction logic combination

### Functions

- The multi-function motion sensor can report movement status, temperature, Lux or dry contacts status to KNX system.
- The multi-function motion sensor supports constant brightness output.
- The recommended assembly height is 2 m –3m. The sensitivity of the detector reduces as the assembly height increases.
- It can controls for Switch control, Absolute dimming control, Shutter control, Alarm control, Percentage control, Sequence control, Scene control, String control, Logic combination control.
- With function of constant brightness: keep the lux in the constant value, will dim the lights to the corresponding intensity according to the surrounding brightness.
- The logic validity can be set by dry contact or external telegram. enable end-user to enable or disable the preset logics.

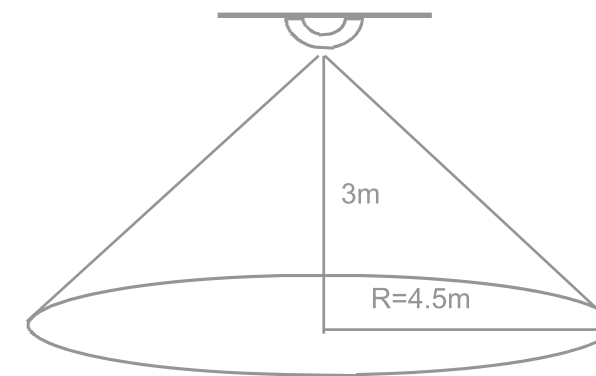

sensing range



## PIR 5logics Sensor

M/IS05.1



- The HDL KNX-M/IS05.1 includes 4 independent logic blocks and 1 combined logic block. The logic process can be AND/OR, the logic inputs can be from the motion sensor, Lux, or other external sensors.
- The sensor can be configured to meet different requirements, and can operate as the master/slave, or individually.

### Specifications

Working voltage: 21-30V DC
BUS interface: KNX/EIB
Dynamic current: <6mA
Static current: <5mA

### Features

This multi-function motion sensor can detect Movement, Lux, and external telegram.
With 5 logic function blocks the unit is capable of independent or combined logic, combining AND/OR processing and outputting up to 10 objects.
The work modes include independent mode, master mode, and slave mode.
Able to report movement and Lux status to the KNX system.
Supports constant brightness output control.
The recommended position of the sensor is 2m-3m above ground level, as the height increases the sensitivity of the sensor is reduced.
The sensor can control switches, absolute dimming, shutters, alarms, sequences, scenes, etc.

## DALI Gateway

M/DALI.1



### Specifications

Working voltage: 21-30V DC
BUS interface: KNX/EIB
Dynamic current: <12mA
Static current: <5mA
Rated voltage: AC85-135V(60Hz) ---USA AC195-265V(50Hz)

### Features

Fault status report
Central control
24 Channel control
16 Group control
32 Scene control
16 Staircase light control
16 Sequence control
16 Emergency light control

- This HDL KNX DALI module can connect up to 64 DALI devices, assign them addresses, and manage the connections. Real-time fault detection is provided which lets users check the status of DALI, lamps, and ballasts. Each channel and group supports switching on/off, relative dimming, absolute dimming, 1bit and 1byte status response. The standard KNX dimming curve, and standard DALI dimming curve is supported.

## Ultrasonic 5logics Sensor

M/US05.1



- The HDL KNX-M/US05.1 includes 4 independent logic blocks and 1 combined logic block. The logic condition can be AND/OR and it can accept ultrasonic input, and Lux input. To meet the needs of different situations the sensor can be configured to operate in master/slave mode or in independent mode.

### Specifications

Working voltage: 21-30V DC
BUS interface: KNX/EIB
Dynamic current: <15mA
Static current: <10mA

### Features

This multi-function motion sensor includes an ultrasonic sensor, Lux sensor, and external telegram detection.
Up to 5 AND/OR processing blocks can each output 10 objects.
When in work mode the unit is able to operate in both master or slave mode.
The device is able to report movement and Lux status to the KNX system.
Supports constant brightness output
The recommended height to install the device is 2m-3m. Sensitivity decreases as the height increases.
It is possible to control switching, absolute dimming, shutters, alarms, sequences, and scenes, etc.

## KNX Timer Master/Slave 4CH Controller

M/TM04.1



### Specifications

Working voltage: 21-30V DC
BUS interface: KNX/EIB
Dynamic current: <10mA

### Features

Master clock	Alarm control
Slave clock	Shutter control
Year routine	Scene control
Month routine	Sequence control
Week routine	Percentage control
Day routine	Threshold control
Special day	Voltage recovery
Switching control	

- Our 4CH Master/Slave Controller fully complies with European safety standards and KNX protocols. Its high Performance EMC Filter is embedded, fully complying the requests of EMC. The timer controller is embedded with a real time clock (RTC), which can be used as a master timer and slave timer.



## KNX HVAC Controller

M/FCU01.10.1

The HVAC Controller is one of the HDL KNX/EIB serials. It can control heating, cooling, and a range of fan speeds.

The HDL HVAC controller supports 7 independent floor heating control channels, and works with digital temperature sensors that can calculate the specific temperature. The unit has 5 relay output channels, and 2 0-10v output channels.



### Specifications

- Working voltage : 21-30V DC
- BUS interface: KNX/EIB
- Dynamic current: <20mA
- Static current: <5mA
- Dynamic power consumption : <450mW
- Static power consumption : <150mW
- Rated current : 250V AC(50/60Hz)
- Relay current: 10A
- Relay electrical life : >100000 times
- Relay mechanical life : >1000000 times

### Features

- |   |                              |
|---|------------------------------|
| ▪ 5 channel 10 A relay output                                   | ▪ Channel runtime statistics |
| ▪ 2 channel 0~10V output  | ▪ Channel status response    |
| ▪ Fan speed : High, medium, low                                 | ▪ Power on recovery          |
| ▪ HVAC working mode : Cooling, heating                          | ▪ Power down status          |
| ▪ HVAC operation mode : Comfort mode, Standby mode, Night mode, | ▪ Staircase light            |
| ▪ Frost/heat protection mode                                    | ▪ Switch delay               |
| ▪ Fan speed, valve status report                                | ▪ Protection delay           |
| ▪ Local 7 channel temperature collection                        | ▪ PWM control output         |
| ▪ Bus temperature collection                                    |                              |
| ▪ Local temperature report                                      |                              |
| ▪ 7 channel independent floor heating control                   |                              |
| ▪ 7 channel independent control output                          |                              |
| ▪ 5 floor heating control mode / channel                        |                              |

### TIPS

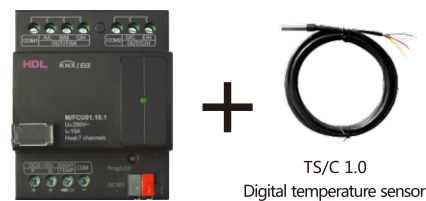

The HVAC Module utilizes a digital temperature sensor, it can use 7 Digital temperature sensors to collect data from different locations and calculate an average temperature.

The HDL HVAC control is used to create a comfortable energy saving environment.

## 4 Channel Dry Contact Sensor

M/S04.1

The dry contact output and input sensor is one of the HDL KNX/EIB serials. It includes a 4 channel signal input and a 4 channel signal output. The signal input channel can receive data from both the temperature sensor and dry contact sensor. It offers a DC output of 0-10v, a dimming signal, or drives the LED status channel.

This module can support temperature data, dry contact inputs, output 5 logics, 0-10 V dimming, various sensors, and LED drivers, etc.

Control of relays, dimming, curtains, and scenes is also possible. Each logic control process is able to combine with 4 signal input channels.

### Specifications

- Working voltage : 21-30V DC
- BUS interface: KNX/EIB
- Dynamic current: <25mA
- Static current: <5mA
- Channel output Voltage : 0-10V
- Channel output current : 3 mA
- Input sensor type: Switch/Temperature sensor

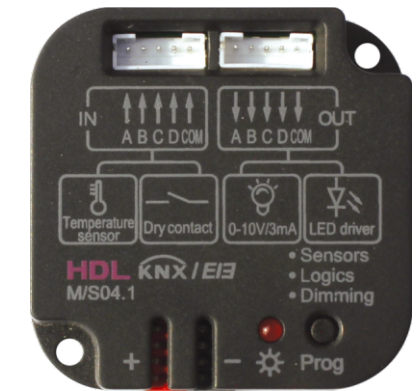

### Features

- |                      |                                      |
|----------------------|--------------------------------------|
| ▪ Switch control     | ▪ Counting control                   |
| ▪ Dimming control    | ▪ Combination control                |
| ▪ Shutter control    | ▪ LED status indicator               |
| ▪ Flexible control   | ▪ Alarm control                      |
| ▪ Scene control      | ▪ Loop time Open statistics          |
| ▪ Sequence control   | ▪ Channel status response            |
| ▪ Percentage control | ▪ Power-state recovery, stair lights |
| ▪ Threshold control  | ▪ Flashing function                  |
| ▪ String control     | ▪ Scene save , scene dimming         |
| ▪ Forced control     | ▪ Threshold switch                   |
| ▪ PWM output         | ▪ Heating control                    |
| ▪ 5 Logic control    | ▪ 0-10V dimming                      |

### TIPS

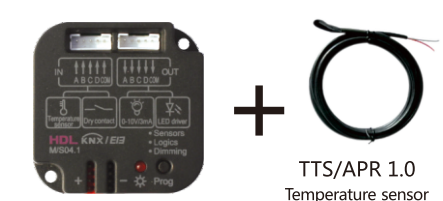

The dry contact sensor works with the temperature sensor to collect and report the temperature.



## Dry Contact 8CH Sensor

M/S08.1



- This dry contact 8CH sensor has dry contact input, and 2 work modes: sensor control and logic control.

### Specifications

- Working voltage: 21-30V DC
- BUS interface: KNX/EIB
- Dynamic current: <30mA
- Static current: <5mA

### Features

- It can send a variety of control telegrams to the KNX system.
- Two work modes: Sensor control, Logic control.
- Logic functionality consists of three parts: dry contact input, logical operation (four levels), logic block output.
- Controls: Switch controller, Switch/Dimming controller, Shutter controller, Flexible controller, Scene controller, Sequence controller, Percentage controller, Threshold controller, String(14 bytes) controller, Forced position controller, Bell controller, Counter controller, Combination controller.

## KNX DMX512 Recorder Module

M/DMX512.1



### Specifications

- Working voltage: 21-30V DC
- BUS interface: KNX/EIB
- Dynamic current: <12mA
- Static current: <5mA

### Features

- A massive 24 programs can be played
- Ability to record 24 programs
- A record time of 4 hours
- KNX to DMX Data exchange
- DMX to KNX Data exchange
- Intelligent sequence control
- Scene output control
- Switch control
- Relative value dimming
- Absolute value dimming
- Input signal: DMX512-1990, HDLNet DMX, ArtNet DMX
- Output signal: DMX512-1990, HDLNet DMX, ArtNet DMX

- The KNX/DMX recorder is not only a KNX/DMX gateway which supports two-way control, it can make, record, play back, and delete DMX programs from the ETS software or KNX wall panel. It has a maximum record time of 4 hours, and can be used to control devices with built-in DMX protocols such as LED color changers, moving lights, or laser lights.

## Dry Contact 24CH Sensor

M/S24.1



- HDL KNX-M/S24.1 is a sensor signal input module, it supports up to 24 dry contact inputs.

### Specifications

- Working voltage: 21-30V DC
- BUS interface: KNX/EIB
- Dynamic current: <30mA
- Static current: <5mA

### Features

- It can sending a variety control telegrams to the KNX system.
- Two work modes: Sensor control, Logic control.
- Controls: Switch controller, Switch/Dimming controller, Shutter controller, Flexible controller, Scene controller, Sequence controller, Percentage controller, Threshold controller, String(14 bytes) controller, Forced position controller, Bell controller, Counter controller, Combination controller. Logical controller mode.

## KNX 960mA Power Supply module

M/P960.1



### Specifications

- Input voltage: AC110V ~ 230V 50/60Hz
- Output voltage: DC30V
- BUS interface: KNX/EIB
- Output current : 960mA
- Power consumption: <2W
- Power-on time: <1s

### Features

- Green LED indicator: Normal output
- Red LED indicator: overload
- Overload and short-circuit protection
- Reset button

- This HDL KNX/EIB 960 mA power supply module fully complies with European safety standards and KNX protocols, it outputs a maximum 960mA current to EIB BUS.



## KNX IR Emitter Module

M/IRAC.1



- The 4 channel HDL-M/IRAC1 IR emitter can store up to 650 IR codes. The first 150 codes are used for controlling televisions, DVD players, music systems, etc. The remaining 500 IR codes are used to control air conditioners, the system is compatible with all air conditioners regardless of manufacturer. The system can turn the AC system on/off, control temperature, fan speed, and louver angle.

### Specifications

- Working voltage: 21-30V DC
- BUS interface: KNX/EIB
- Dynamic current: <15mA
- Static current: <5mA
- Maximum effective distance: 6m

### Features

- Singe control
- Repeat control
- Split AC control
- Sequence control
- Current detection

### IR Codes

- The HDL-KNX Assistant Software allows the system to learn new codes and download them to the KNX IR Emitter Module.

## KNX USB Interface

M/USB.1

### Specifications

- Bus voltage: 21-31DC
- Bus interface: KNX/EIB
- BUS current: <10mA
- Installation: Standard 35mm Din Rail
- Type of connection: KNX/EIB Connector
- USB Interface 1.0 HID
- Dimensions: 70x36x90mm (LxWxH)
- IP class: IP20

### Features

- Type B USB Connector
- Automatic recognition of PC and KNX equipment to be programmed
- LED indication of data transmission
- Usable from ETS4/3
- Automatic detection and installation of the USB interface
- Easy access USB connection



- The M/USB.1 is a new KNX-USB interface, it establishes a bidirectional data connection between a PC and KNX bus. Protection of the KNX BUS is ensured through the galvanic isolation of the USB connector. The device enables addressing, setting of parameters, visualization, protocolling, and the diagnosis of bus devices. With a KNX-USB interface you have the possibility of addressing every bus device in the system. Located on the front of the device the USB socket is easy to find, and has twin yellow LEDs which indicate the status and traffic between the bus and PC.

## KNX net/IP Router

M/IPRT.1



M/IPRT.1: KNX net/IP Router

- The KNX net/IP can connect the two communication protocols to effectively send/receive data.

### Specifications

- KNX Bus voltage: DC21-30V
- KNX Bus current: 5mA
- External power supply: DC 24V (DC 12 to 30V)
- Power consumption: typ. 520mW, max. 800mW
- External current: typ. 190mA
- Dimensions: 70x36x90mm (L x W x H)
- IP Class: Ip20

### Features

- The KNX net/IP Routing & Tunneling interface device offers a router the ability to temporarily disable the filtering of messages by pressing a button.
- This eases system commissioning considerably.
- Temporary access to other lines is possible without having to download data from the ETS.
- If the bus experiences communication failure, the user is notified by the devices onboard LEDs.

## KNX Line Coupler / Repeater

M/LCR.1

### Specifications

- Bus Voltage: 21-31DC
- Bus Interface: KNX/EIB
- BUS Main Line Current: <30mA
- BUS Secondary Line Current: 3mA
- Installation: Standard 35mm Din Rail
- Connections: KNX / EIB Main line - Left bus connection terminal
- KNX / EIB Sub line - Right bus connection terminal
- Dimensions: 70x36x90mm (L x W x H)
- IP Class: IP20

### Features

- Line coupler for connecting wide KNX lines or areas
- Filter functionality, telegrams can be filtered to reduce telegram traffic.
- Galvanic isolation of the lines/areas
- 6 LEDs display data transmission and 1 LED displays programming mode
- Can be used as line amplifier/repeater as well



- The HDL-KNX Line Coupler can be used as coupler or repeater (to amplify the signal). If the device is used as a line coupler, it can be linked with the sub-line or main-line. A separate power supply including choke is required for each new line segment, each line will still be electrically isolated. The Line Coupler can filter telegrams and pass or block them to other lines.



## KNX 4 Core Shield Cable

HDL BUS/KNX/EIB

HDL-BUS & KNX/EIB 4 core shield cable is specifically designed to be used with HDL devices.  
The HDL-BUS and KNX/EIB Cable gives optimum data transmission, and is the recommended choice when wiring HDL devices.

### HDL BUS/KNX/EIB/4 Core Shield Cable



Connection:

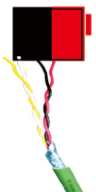

Red: Connect Power Positive  
Black: Connect Power Negative

### Specifications

- Twisted Pair: 2 twisted pair (red and black, white and yellow)
- Cable Description: Aluminum foil shield, ground line
- Insulation resistance(70°C): >5X106ohm/km
- Conductor resistance(20°C): <35 ohm/km
- Copper Wire diameter: 0.75~0.85mm
- Cable withstand voltage: AC 300V
- Cable diameter: 7.0~8.0mm
- Impedance: 120 ohm
- Twisted No.: 40/m

### Environment conditions

- Working temperature: -20°C~85°C
- Working relative Humidity: 10%~98%
- Storage temperature: -40°C~+100°C
- Storage relative humidity: 10%~98%

### Features

- 4 core shield cable: red, black, white, yellow
- Strong signal transmission capability
- Strong anti-jamming capability

## HDL Assistant Software V1.0

FREE SOFTWARE

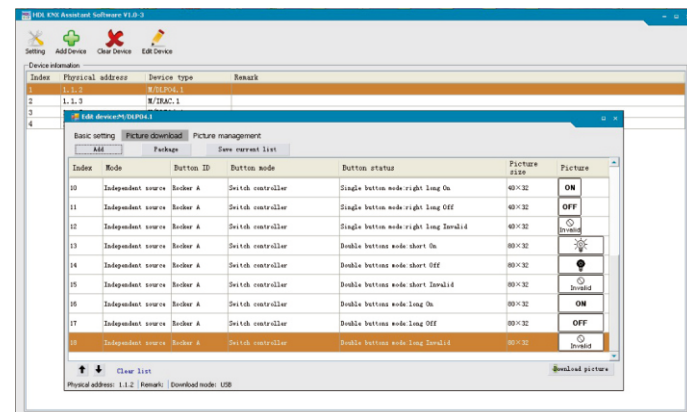

### For KNX DLP Panel (M/DLP04.1)

- Personalize your DLP's screen by downloading Icons to the KNX DLP Intelligent Panel using the HDL-KNX Assistant Software.

### For KNX IR Emitter Module (M/IRAC.1)

- Enable your system to learn new IR codes by downloading them to the KNX IR Emitter Module using the HDL-KNX Assistant Software.

### For KNX DALI Module(M/DALI.1)

- Manage your DALI devices and their automatic address allocations, and create 16 DALI device groups.

- HDL-KNX Assistant Software is designed to aid system creation, and commissioning. The software is being constantly improved to offer you more customization and configuration possibilities.

## KNX Product List

### US Standard Panel

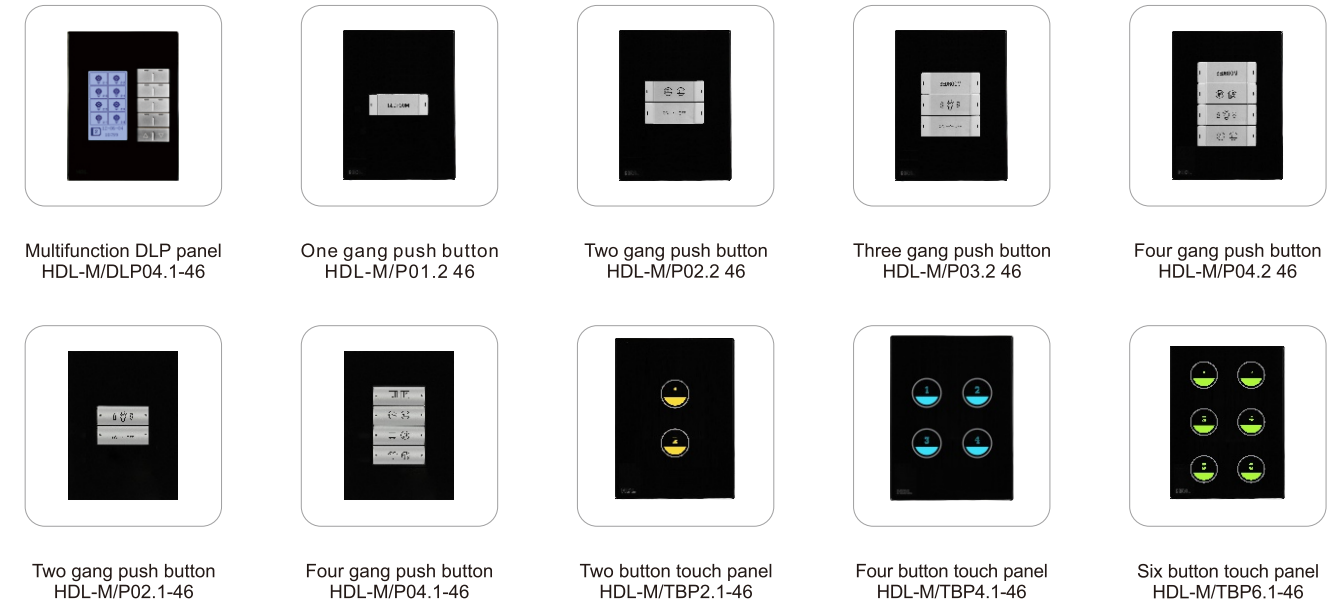

## KNX Product List

### EU Standard Panel

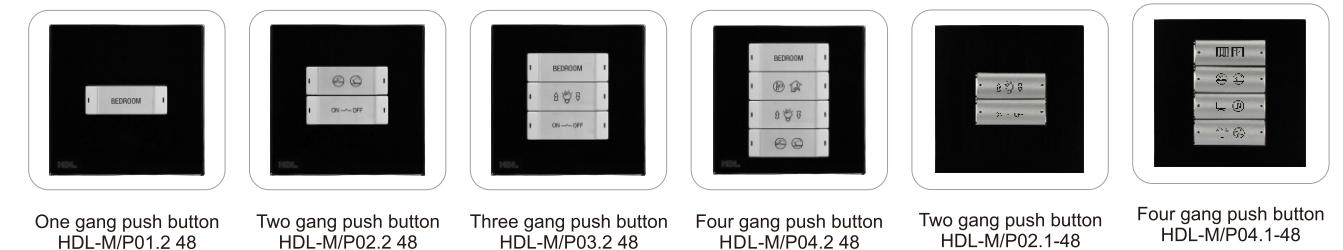

### South Korea Standard Panel

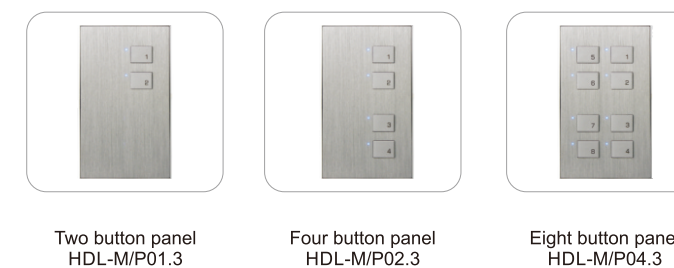

### EU Standard LCD Panel





EU Standard Touch Panel

EU Standard Touch Panel      RGBW 4 fold Driver



One button touch panel HDL-M/TBP1.1-48    Two button touch panel HDL-M/TBP2.1-48    three button touch panel HDL-M/TBP3.1-48    Four button touch panel HDL-M/TBP4.1-48    RGBW 4 fold Driver M/WM70M.1

Panel Controller-C



Panel 1Rocker Controller-PV2(V1.2) M/P01.2-C1    Panel 2Rocker Controller-PV2(V1.2) M/P02.2-C2    Panel 2Rocker Controller-PV2(V1.2) M/P02.2-C3    Panel 2Rocker Controller-PV2(V1.2) M/P02.2-C4    Panel 3Rocker Controller-PV2(V1.2) M/P03.2-C    Panel 3Rocker Controller-PV2(V1.2) M/P03.2-C6

Power Supply Module      Relay Series



KNX 960mA power module HDL-M/P960.1    4ch 10A relay module HDL-M/R04.10.1    8ch 10A relay module HDL-M/R08.10.1    12ch 10A relay module HDL-M/R12.10.1    16ch 10A relay module HDL-M/R16.10.1

DMX Recorder      Relay Series



KNX DMX512 recorder HDL-M/DMX512.1    4ch 16A relay module HDL-M/R4.16.1    8ch 16A relay module HDL-M/R8.16.1    12ch 16A relay module HDL-M/R12.16.1    16ch 16A relay module HDL-M/R16.16.1

Ultrasonic & Motion sensor      Motion Sensor



5 logic Ultrasonic & Motion Sensor M/HSIU05.1    KNX Outdoor Doppler Sensor M/WS05.1-A    KNX Indoor Doppler Sensor M/WS05.1-B    5 logic motion sensor M/HS05.1    PIR 5logics Sensor M/IS05.1    Ultrasonic 5logics Sensor M/US05.1

Dimmer Series      DALI Gateway



1ch 6A dimmer module HDL-M/D01.1    2ch 3A dimmer module HDL-M/D02.1    4ch 1.5A dimmer module HDL-M/D04.1    4ch 3A dimmer module HDL-M/DL04.1    DALI Gateway HDL-M/DALI.1

KNX Timer Module



6ch 2A dimmer module HDL-M/DL06.1    6ch 0-10V ballast dimmer HDL-M/DA6.10.1    6ch 1A dimmer module HDL-M/D06.1    2ch 6A dimmer module HDL-M/DL02.1    KNX Timer Master/Slave 4CH Controller HDL-M/TM04.1

Curtain Controller Series      Motor Curtain      IR Emitter



2ch curtain controller HDL-M/W02.10.1    4ch curtain controller HDL-M/W04.10.1    6ch curtain controller HDL-M/W06.10.1    1CH Actuator M/WM70M.1    IR emitter HDL-M/IRAC.1

Dry contact input module      HVAC control module      KNX Cable



4ch dry contact input module HDL-M/S04.1    Dry Contact 8CH Sensor HDL-M/W04.10.1    Dry Contact 24CH Sensor HDL-M/S24.1    HVAC control module HDL-M/FCU01.10.1    4 Core shield cable HDL BUS/KNX/EIB

Line Coupler / Repeater      USB Interface      KNX net/IP Router



KNX Line Coupler / Repeater HDL-M/LCR.1    KNX USB Interface HDL-M/USB.1    KNX net / IP Router M/IPRF.1



# FEDERATION OF KOREAN INDUSTRIES

SEOUL, SOUTH KOREA

## HDL-KNX PROJECTS



### Description

The Federation of Korean Industries headquarters utilized 963 HDL-KNX products. This beacon of Seoul's skyline heralded the importance of smart energy saving in large skyscrapers. The building is 240 meters tall (800ft), and features an innovative exterior glass facade designed specifically to reduce the internal heating and cooling loads.

Energy is collected by integrating photovoltaic panels into the spandrel areas of the southwest and northwest facades, these are the areas which receive most direct sunlight.

By angling the spandrel panels 30 degrees upwards, the design team maximized the amount of energy collected, this energy is enough to power the electrical systems throughout the tower core and the office space.

The KNX solution chosen used a total of 290 HDL-KNX Relays(M/Rx.16.1 series) which provide an output current of 16 Amperes per channel.

Inside the building, 457 HDL-KNX Sensors composed the Lux and motion net. These sensors were essential as they helped to control the skin of the building, enabling it to save energy at different times of the day.

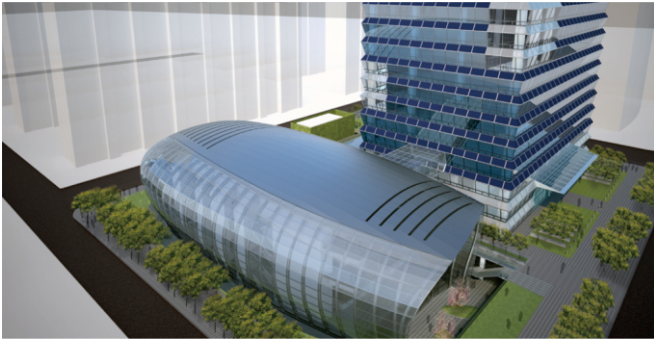



## WALEXPO EXHIBITION COMPLEX AND BUSINESS CENTER

↳ ARDENES, BELGIUM

## KL SENTRAL RAILWAY STATION

↳ KUALA LUMPUR, MALAYSIA



### Description

Walexpo is a multi functional, innovative, passive, exhibition complex and business center. Situated in the rural heart of the Belgian Ardennes, it is the first European building that adheres to passive energy criteria. Its contemporary design covers an area of 25,000m<sup>2</sup>, and is located in the midst of a superbly landscaped park that covers some 60 hectares.

### Description

Kuala Lumpur Sentral is an exclusive urban center built around Malaysia's largest transit hub, offering global connectivity, excellent investment opportunities, business convenience and an international lifestyle.

The HDL-KNX/EIB building automation system was applied in 4 basement floors, 7 shopping mall floors, and 27 office floors. This gave the end user total control of over 6000 channels and their lighting loads.





## MEDIAMARKT STORE PROJECT

↳ ZWIJNAARDE, BELGIUM

## CHATEAU DU FAING PROJECT

↳ CHINY, BELGIUM



### Description

Media Markt is a German chain of stores selling consumer electronics with numerous branches throughout Europe and Asia; it is Europe's largest retailer of consumer electronics, and the second largest in the world after American retailer Best-Buy.

The project required several relay modules to be installed that could split the store into sectors, and control different devices. The chosen user interface to control the HDL systems was a touchscreen installed in the manager's office.

### Description

HDL was selected to retrofit this 12th century castles electrical systems. Nestled in the south east of Belgium the castle lies close to the small village of Jamoigne.

The end-user required total control of lighting and HVAC, to meet these needs HDL-KNX solutions were installed.

Due to the castles immense dimensions, the installation required countless HDL power supply modules and relays.

The end result is a perfect blend of old and new, ancient and modern, giving the best of both worlds to the customer.

