

## APPLICATION PROGRAM INFORMATION

Dry Contact 4CH Sensor

M/S04.1

KNX/EIB-BUS

Document Version: 1.0, Date: 15. April.2015

This document describes the M/S04.1-functions with the KNX-product- application:

Dry Contact 4CH Sensor (V1.1).vd5

This product can be used with the optional HDL temperature sensor TTS/APR 1.0, which is specified in its Technical Product Information V1.0, date03. April 2015

Compiled by (english name): Mr. He

HDL-Position: Technical Manager, KNX-Products

Location: Gungzhou Date: 15. April.2015 Signature: 何海荣

Approved by (english name): Dicky Du

HDL-Position: Technical Manager

Location: Gungzhou Date: 15. April.2015 Signature: 杜其昌

Document History			
Version	Date	Comments	Author (english name)
1.0	27.12.2014	First issue	Sally Li

- A. General description
- B. Function overview flowchart
- C. Function description
- D. Communication objects

A.

The Dry Contact 4CH Sensor is used to operate building functions. Its design enables it to be mounted in a 60mm wiring box. This manual contains the programming of this device.

B.

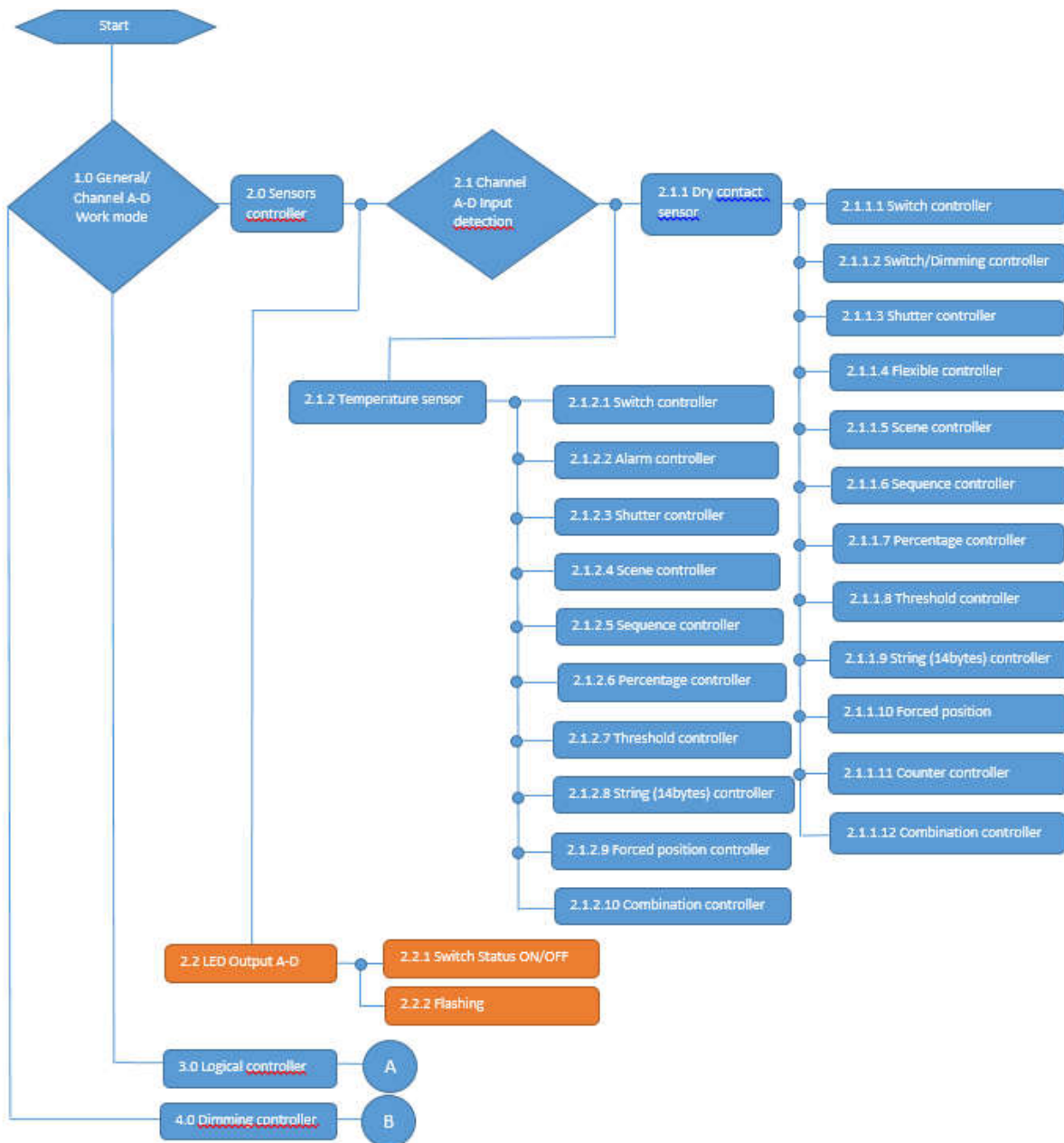

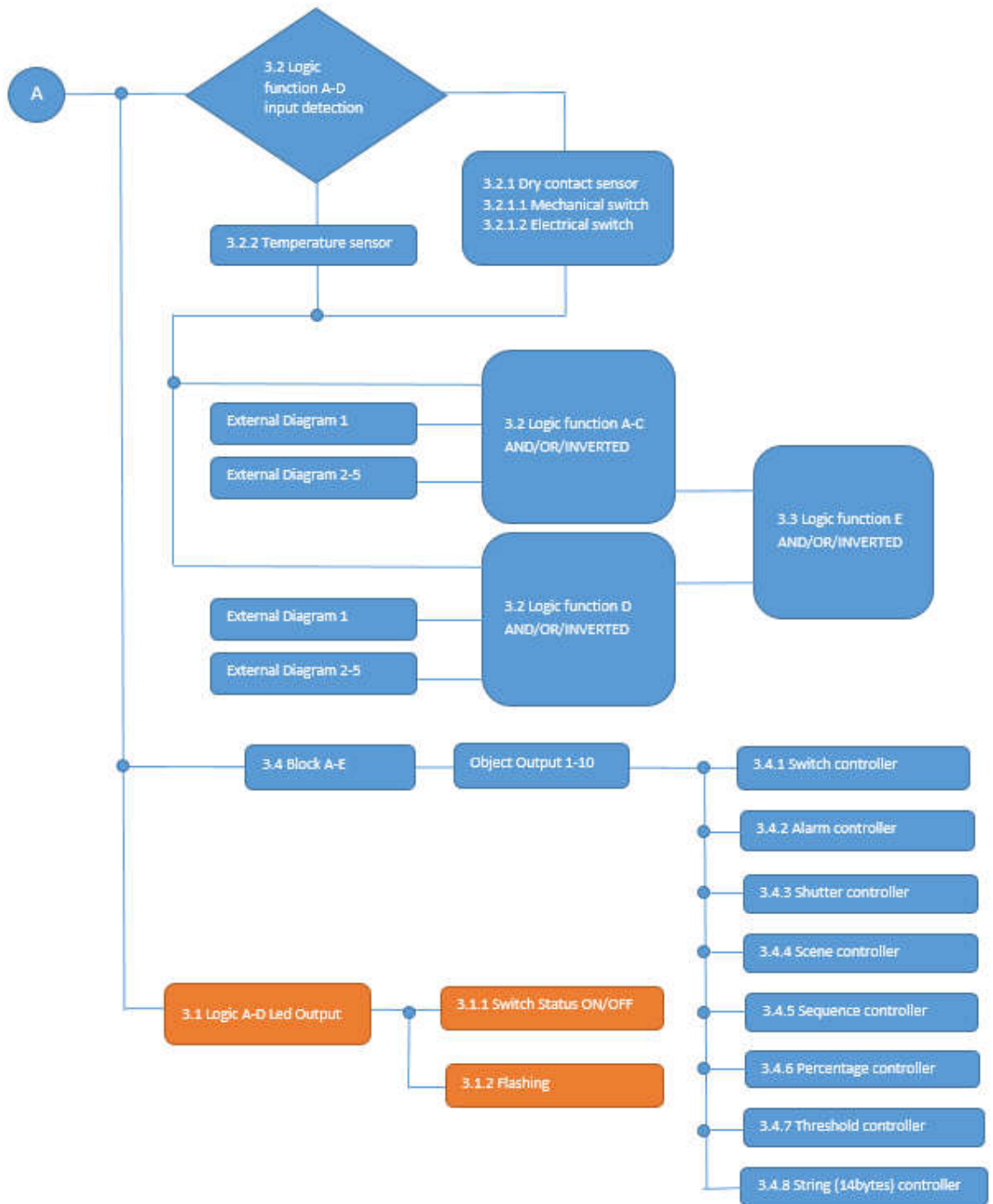

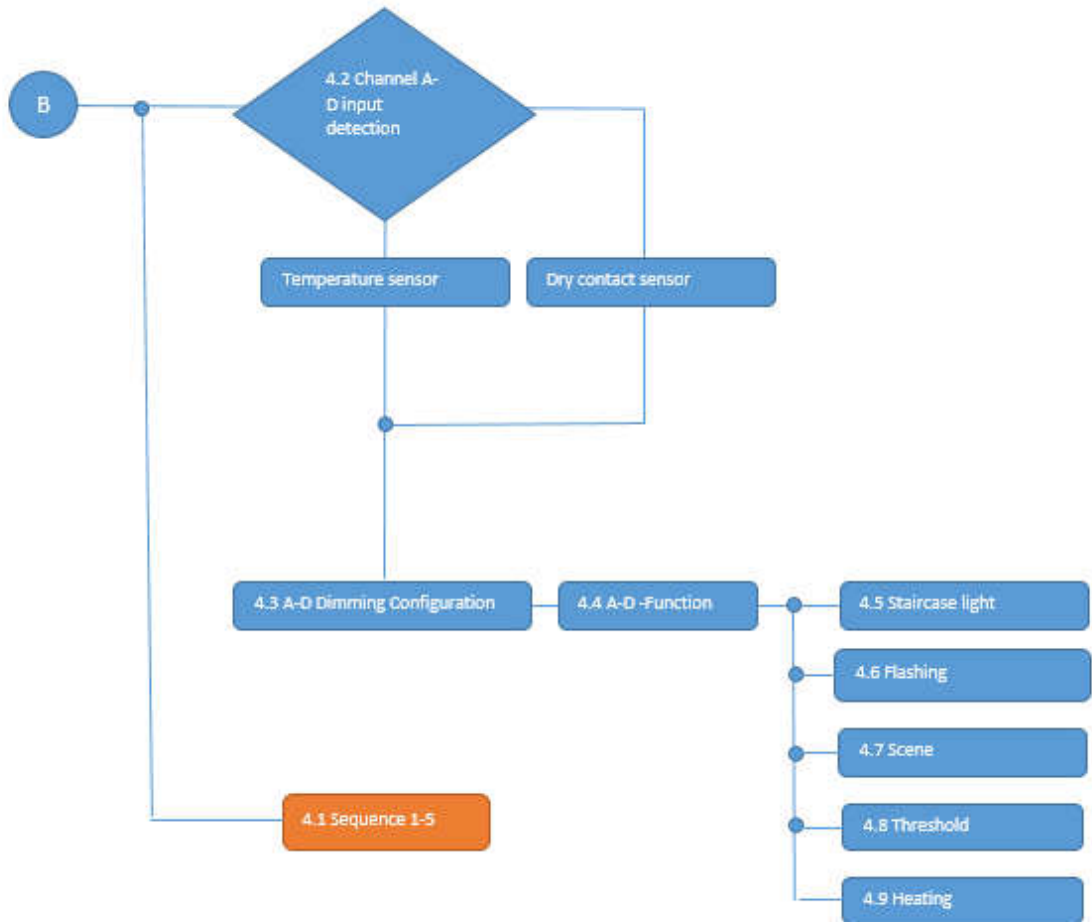

C.

1.0\_General/Channel A-D Work mode/ 2.0\_Sensors controller

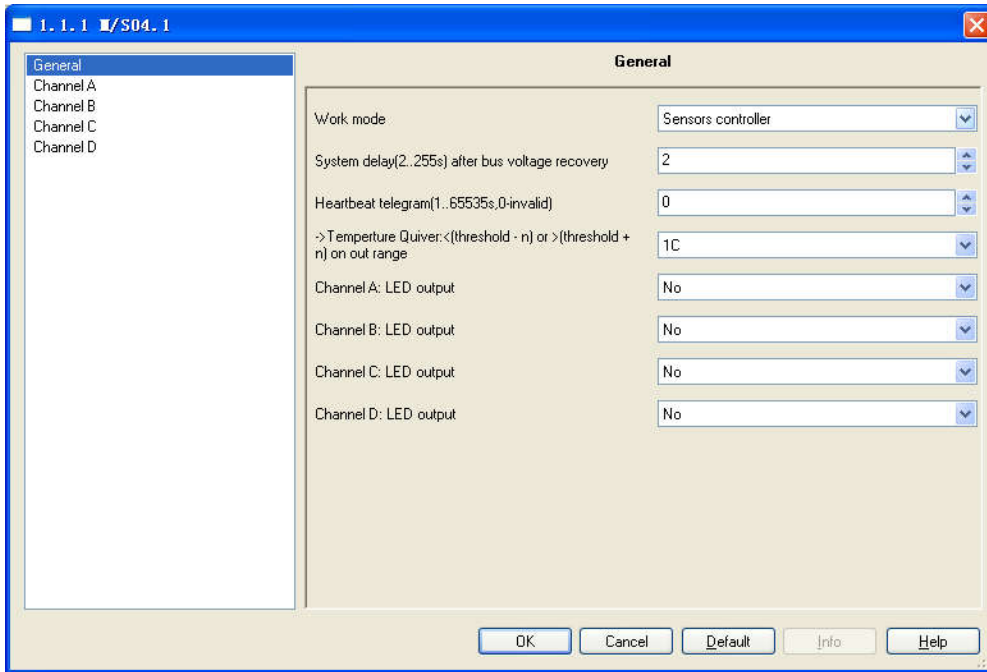

No.	ETS-Parameter	Range (default)	Description
1	Work mode	- (Sensors controller) - Logical controller - Dimming controller	Set the work mode-sensors controller
2	System delay (2-255s) after bus voltage recovery	(2)..255s	Set the delay time for the device to work after power on, the range is 2-255s
3	Heartbeat telegram (1..65535s,0-invalid)	(0)..65535s	If the parameter is set to nonzero, the device will send a telegram data (alternately between 0 and 1) cyclically after time out; if it's set to 0, this function is invalid.
4	Temperature Quiver: <(threshold - n) or >(threshold +n) on out range)	0C, (1C),...10C	The effective range is larger than threshold1 and less than threshold2 The setting range is larger than the (threshold1-n) and less than (threshold2+n). Suppose the temperature is in the effective range, when it changes within the setting range, the status will not change. Suppose the temperature is in the effective range, when it changes out of the setting range, the status will change. Suppose the temperature is not in the effective range, only when the temperature changes into the effective

			<i>range, the status will change.</i>
5	Channel A: LED output Channel B: LED output Channel C: LED output Channel D: LED output	(NO), YES	<i>If select YES, it will appear a setting page of the "LED output A". That page is used to set the LED state parameter. Channel B,C,D outputs are same as Channel A.</i>

2.1\_Channel A-D, Input detection

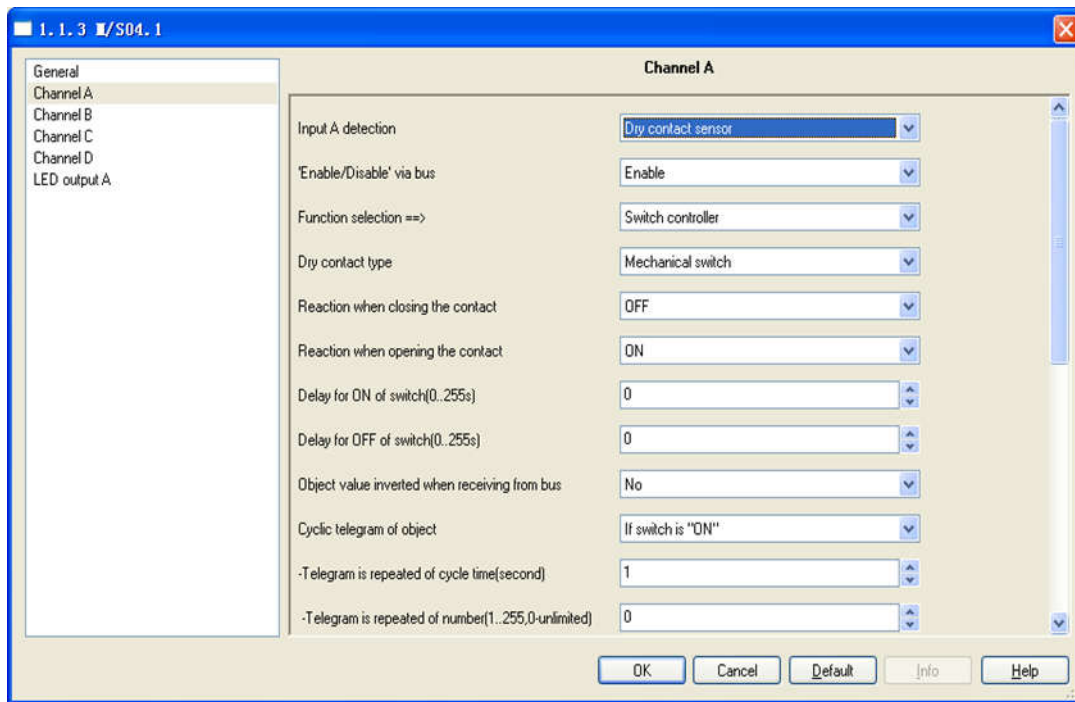

No.	ETS-Parameter	Range (default)	Description
6	Input A detection	-(No detection) -Dry contact sensor -Temperature sensor	<i>Function selection</i>
<b>2.1.1_Dry contact sensor</b>			
7	Enable/Disable via bus	(Disable), Enable	<i>If select 'Enable', you can enable/disable the channel A via bus</i>
8	Function selection==>	-(Switch controller) -Switch / Dimming controller -Shutter controller -Flexible controller -Scene controller -Sequence controller -Percentage controller -Threshold controller -String (14bytes) controller -Forced position controller -Counter controller -Combination controller	<i>Select the output control function you need.</i>
<b>2.1.1.1_Switch controller</b>			
9	Dry contact type	-(Mechanical switch) -Electronic switch	<i>Mechanical switch: it has two states, "OFF" and "ON". You can set commands to each</i>



			state.(act as a bi-stable button)Electronic Switch: act as a mono-stable button.
<b>2.1.1.1.1_Mechanical switch</b>			
10	Reaction when closing the contact	-Unchanged -(ON) -OFF -Toggle -Stop cyclic telegram	<b>Unchanged:</b> It will send the same value as the last time. <b>ON:</b> The value it will send is 1. <b>OFF:</b> The value it will send is 0. <b>Toggle:</b> It will invert the last time's value then send it out. <b>Stop cyclic telegram:</b> This is mainly used for the following cyclic settings.
11	Reaction when opening the contact	-Unchanged -ON -(OFF) -Toggle -Stop cyclic telegram	<b>Unchanged:</b> It will send the same value as the last time. <b>ON:</b> The value it will send is 1. <b>OFF:</b> The value it will send is 0. <b>Toggle:</b> It will invert the last time's value then send it out. <b>Stop cyclic telegram:</b> This is mainly used for the following cyclic settings.
12	Delay for ON of switch(0..255s)	(0)..255	Set the delay time for switch on
13	Delay for OFF of switch(0..255s)	(0)..255	Set the delay time for switch off
14	Object value inverted when receiving from bus	-(NO) -YES	<b>NO:</b> It will not invert the receiving value <b>YES:</b> It will invert the receiving value
15	Cyclic telegram of object	-(NO) -if switch is "ON" -if switch is "OFF" -Always transmission	<b>NO:</b> There is not cyclic function. <b>If switch is ON:</b> It will send out the telegram cyclically when the switch is on. <b>If switch is OFF:</b> It will send out the telegram cyclically when the switch is off. <b>Always transmission:</b> No matter the switch is on or off, it will send out the telegram cyclically.
16	Transmit object value after bus voltage recovery	NO,(YES)	Whether transmit object value after bus voltage recovery.
17	The operation time interval: base	-(10ms) -100ms -1sec -1min -1hour	These two parameters are used to set the time interval of repeat operation, the time interval = base*factor.
18	Factor[1..255]- >time=base*factor	(1)...255	These two parameters are used to set the time interval of repeat operation, the time interval = base*factor.

2.1.1.1.2 Electronic switch			
19	The normally contact status is	Closed/(Open)	<p>Set the dry contact's normal status when have nooperation.</p> <p><b>Closed:</b>The dry contact's normal status is closed.</p> <p><b>Open:</b>The dry contact's normal status is open</p>
20	Reaction when short button operation	-Invalid -Unchanged -ON -OFF -(Toggle)	Set the output control type when short press the button
21	Reaction when long button operation	-(Invalid) -Unchanged -ON -OFF -Toggle	Set the output control type when long press the button
22	Long button time after	0.2s..(1s)..60s	Set time for long-press, define the long press by end-user
23	Delay for ON of switch(0..255s)	(0)..255	Set the delay time for switch on
24	Delay for OFF of switch(0..255s)	(0)..255	Set the delay time for switch off
25	Object value of short button inverted when receive from bus	-(NO) -YES	<p><b>NO:</b> It will not invert the receiving value</p> <p><b>YES:</b> It will invert the receiving value</p>
26	Object value of long button inverted when receive from bus	-(NO) -YES	<p><b>NO:</b> It will not invert the receiving value</p> <p><b>YES:</b> It will invert the receiving value</p>
27	The operation time interval: base	-(10ms) -100ms -1sec -1min -1hour	These two parameters are used to set the time interval of repeat operation, the time interval = base*factor.
28	Factor[1..255]->time=base*factor	(1)...255	These two parameters are used to set the time interval of repeat operation, the time interval = base*factor.

2.1.1.2\_Switch/Dimming controller

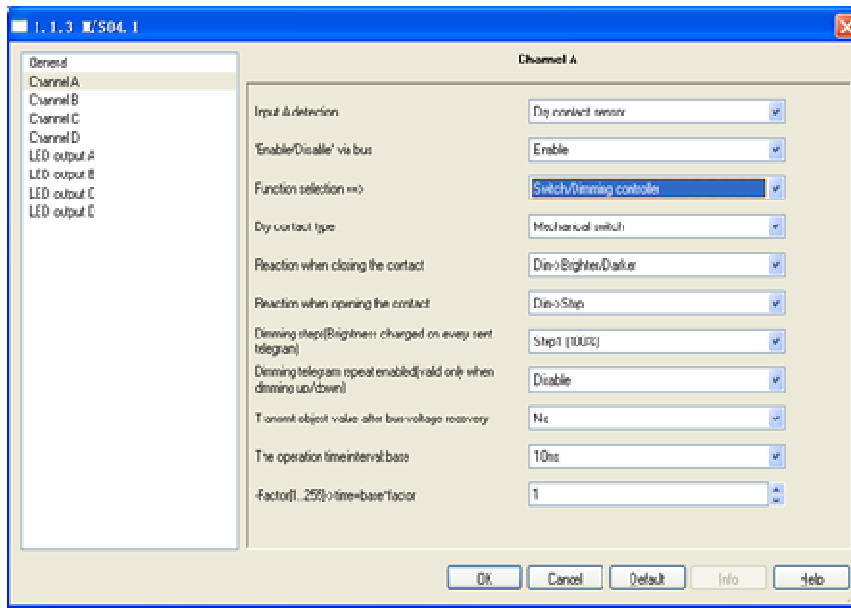

No.	ETS-Parameter	Range (default)	Description
29	Dry contact type	-(Mechanical switch) -Electronic switch	<i>Function selection</i>
<b>2.1.1.2.1_Mechanical switch</b>			
30	Reaction when closing the contact	-Invalid -Dim->Brighter -Dim->Darker -(Dim-> Brighter/Darker) -Dim-> Stop	<b>Invalid:</b> no action when closing the dry contact. <b>Dim-&gt;Brighter:</b> When closing the dry contact, it will increase the brightness. <b>Dim-&gt;Darker:</b> When closing the dry contact, it will decrease the brightness. <b>Dim-&gt; Brighter/Darker:</b> When closing the dry contact, it will increase/decrease the brightness. <b>Dim-&gt;Stop:</b> when closing the dry contact, it will stop dimming.
31	Reaction when opening the contact	-Invalid -Dim->Brighter -Dim->Darker -Dim-> Brighter/Darker -(Dim-> Stop)	<b>Invalid:</b> no action when opening the dry contact. <b>Dim-&gt;Brighter:</b> When opening the dry contact, it will increase the brightness. <b>Dim-&gt;Darker:</b> When opening the dry contact, it will decrease the brightness. <b>Dim-&gt; Brighter/Darker:</b>

			<p>When opening the dry contact, it will increase/decrease the brightness.</p> <p><b>Dim-&gt;Stop:</b>when opening the dry contact, it will stop dimming.</p>
32	Dimming steps (Brightness changed on every sent telegram)	-Step1 (100%) -Step2 (50%) -Step3 (25%) ..Step7 (1.56%)	Set the dimming values when sends out the dimming telegram
33	Dimming telegram repeat enabled (valid only when dimming up/down)	(Disable), Enable	<p>Whether repeat sending dimming telegram.</p> <p><b>Disable:</b> do not repeat sending dimming telegram.</p> <p><b>Enable:</b> when dimming up/down will repeat sending dimming telegram.</p>
34	Dimming telegram repeated time	0.2s..(0.4s)..60s	The interval of sending dimming telegram
35	Dimming telegram repeated number (1..255,0-unlimited)	(0)..255	The repeat times of sending dimming telegram
36	Transmit object value after bus voltage recovery	-(NO) -YES	Whether transmit object value after bus voltage recovery.
37	The operation time interval: base	(10ms)..1hour	These two parameters are used to set the time interval of repeat operation, the time interval = base*factor.
38	Factor[1..255]- >time=base*factor	(1)...255	These two parameters are used to set the time interval of repeat operation, the time interval = base*factor.
<b>2.1.1.2.2 Electronic switch</b>			
39	The normally contact status is	Closed/(Open)	<p>Set the dry contact's normal status when have nooperation.</p> <p><b>Closed:</b>The dry contact's normal status is closed.</p> <p><b>Open:</b>The dry contact's normal status is open</p>
40	Reaction when short button operation	-Invalid -Unchanged -ON -OFF -(Toggle)	Set the output control type when short press the button
41	Reaction when long button operation	-Invalid -Dim->Brighter -Dim->Darker -(Dim-> Brighter/Darker)	Set the output control type when long press the button
42	Long button time after	0.2s..(1s)..60s	Set time for long-press, define the long press by end-user
43	Delay for ON of switch(0..255s)	(0)..255	Set the delay time for switch on

44	Delay for OFF of switch(0..255s)	(0)..255	Set the delay time for switchoff
45	Dimming steps (Brightness changed on every sent telegram)	-(Step1 (100%)) -Step2 (50%) -Step3 (25%) ..Step7 (1.56%)	Set the dimming values when sends out the dimming telegram
46	Dimming telegram repeated enable	(Disable), Enable	Whether repeat sending dimming telegram. <b>Disable:</b> do not repeat sending dimming telegram. <b>Enable:</b> when dimming up/down will repeat sending dimming telegram.
47	Dimming telegram repeated time	0.2s..(0.3s)..60s	The interval of sending dimming telegram
48	Dimming telegram repeated number (1..255,0-unlimited)	(0)..255	The repeat times of sending dimming telegram
49	The operation time interval: base	(10ms)..1hour	These two parameters are used to set the time interval of repeat operation, the time interval = base*factor.
50	Factor[1..255]->time=base*factor	(1)...255	These two parameters are used to set the time interval of repeat operation, the time interval = base*factor.

2.1.1.3\_Shutter controller

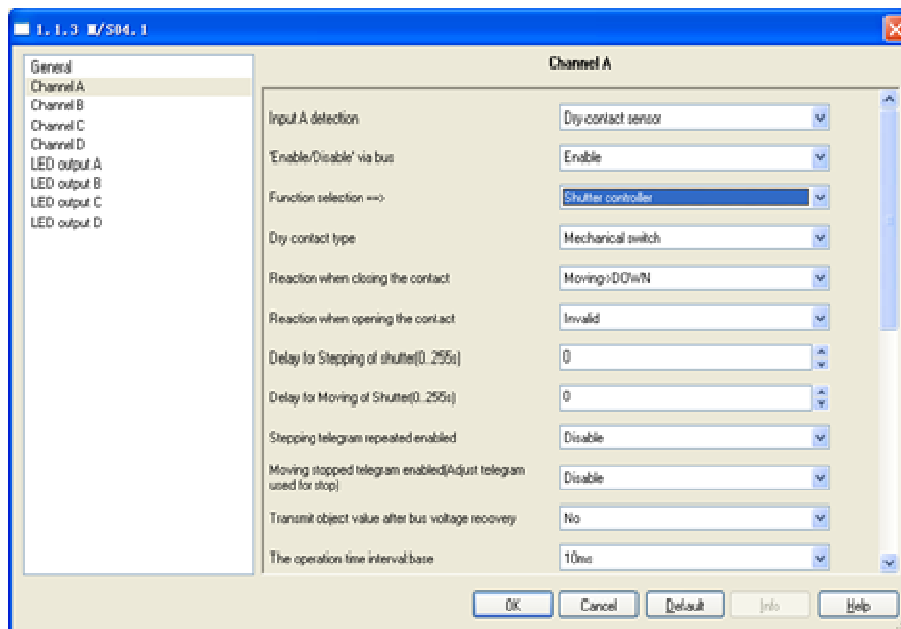

No.	ETS-Parameter	Range (default)	Description
51	Dry contact type	-(Mechanical switch) -Electronic switch	Function selection
<b>2.1.1.3.1_Mechanical switch</b>			
52	Reaction when closing the	-Invalid	<b>Invalid:</b> no action when

	contact	<p>-Stepping-&gt;Increase                      -Stepping-&gt;Decrease                      -Stepping-&gt;Toggle                      -Stepping-&gt;Repeat telegram stopped                      -Moving-&gt;UP                      -(Moving-&gt;DOWN)                      -Moving-&gt;Toggle</p>	<p><i>closing the dry contact.</i>  <b>Stepping-&gt;Increase:</b> When closing the dry contact, it will increase the angle of louver.  <b>Stepping-&gt; Decrease:</b>When closing the dry contact, it will decrease the angle of louver.  <b>Stepping-&gt; Toggle:</b> When closing the dry contact, it will increase/decrease the angle of louver.  <b>Stepping-&gt;Repeat telegram stopped:</b> When closing the dry contact, it will stop repeat sending stepping telegram  <b>Moving-&gt; UP:</b> When closing the dry contact, it will send move up telegram  <b>Moving-&gt; Down:</b> When closing the dry contact, it will send move down telegram  <b>Moving-&gt; Toggle:</b> When closing the dry contact, it will send move up/down telegram</p>
53	Reaction when opening the contact	<p>-(Invalid)                      -Stepping-&gt;Increase                      -Stepping-&gt;Decrease                      -Stepping-&gt;Toggle                      -Stepping-&gt;Repeat telegram stopped                      -Moving-&gt;UP                      -(Moving-&gt;DOWN)                      -Moving-&gt;Toggle</p>	<p><b>Invalid:</b> no action when opening the dry contact.  <b>Stepping-&gt;Increase:</b> When opening the dry contact, it will increase the angle of louver.  <b>Stepping-&gt; Decrease:</b>When opening the dry contact, it will decrease the angle of louver.  <b>Stepping-&gt; Toggle:</b> When opening the dry contact, it will increase/decrease the angle of louver.  <b>Stepping-&gt;Repeat telegram stopped:</b> When opening the dry contact, it will stop repeat sending stepping telegram  <b>Moving-&gt; UP:</b> When opening the dry contact, it will send move up telegram  <b>Moving-&gt; Down:</b> When opening the dry contact, it will send move down telegram  <b>Moving-&gt; Toggle:</b> When opening the dry contact, it will send move up/down telegram</p>
54	Delay for Stepping of Shutter(0..255s)	(0)..255	Set the delay time for adjusting the angle of louver
55	Delay for Moving of	(0)..255	Set the delay time for the

	Shutter(0..255s)		<i>shutter moving</i>
56	Stepping telegram repeated enabled	-(Disable) -Enable	<i>Whether repeat sending adjusting telegram. <b>Disable:</b> do not repeat sending adjusting telegram. <b>Enable:</b> it will repeat sending the adjusting telegram.</i>
57	Stepping telegram repeated time	(0.2s)..60s	<i>The interval of sending adjusting telegram</i>
58	Stepping telegram repeated number (1...255, 0-unlimited)	(0)..255	<i>The repeat times of sending dimming telegram</i>
59	Moving stopped telegram enabled(Adjust telegram used for stop)	-(Disable) -Enable	<i>Enable/disable the function to auto stop the shutter after moving</i>
60	Moving stopped telegram delay time: base	100ms,(1sec)..1hour	<i>These two parameters are used to set the delay time to stop the shutter after moving, the delay time = base*factor.</i>
61	Factor[1..255]- >time=base*factor	(10)...255	<i>These two parameters are used to set delay time to stop the shutter after moving, the delay time = base*factor.</i>
62	Transmit object value after bus voltage recovery	-(NO) -YES	<i>Whether transmit object value after bus voltage recovery. <b>NO:</b> do not transmit object value after bus voltage recovery. <b>YES:</b> it will transmit object value after bus voltage recovery.</i>
63	The operation time interval: base	(10ms)..1hour	<i>These two parameters are used to set the time interval of repeat operation, the time interval = base*factor.</i>
64	Factor[1..255]- >time=base*factor	(1)...255	<i>These two parameters are used to set the time interval of repeat operation, the time interval = base*factor.</i>
<b>2.1.1.3.2 Electronic switch</b>			
65	The normally contact status is	Closed/(Open)	<i>Set the dry contact normal status when has no operation.</i>
66	Reaction when short button operation	-Invalid -(Stepping->Increase/STOP) -Stepping->Decrease/STOP -Stepping->Toggle/STOP -Moving->UP -Moving->DOWN -Moving->Toggle	<i><b>Invalid:</b> no action when short press the button <b>Stepping-&gt;Increase/Stop:</b>when short press the button, it will increase/stop the angle of louver. <b>Stepping-&gt;Decrease/Stop:</b>when short press the button, it will decrease/stop the angle of louver. <b>Stepping-&gt; Toggle/Stop:</b></i>

			<p>when short press the button, it will toggle/stop the angle of louver.</p> <p><b>Moving-&gt; UP:</b> When short press the button, it will send move up telegram</p> <p><b>Moving-&gt; Down:</b> When short press the button, it will send move down telegram</p> <p><b>Moving-&gt; Toggle:</b> When short press the button, it will send move up/down telegram</p>
67	Reaction when long button operation	<p>-Invalid</p> <p>-Stepping-&gt;Increase/STOP</p> <p>-Stepping-&gt;Decrease/STOP</p> <p>-Stepping-&gt;Toggle/STOP</p> <p>-Moving-&gt;UP</p> <p>-Moving-&gt;DOWN</p> <p>-(Moving-&gt;Toggle)</p> <p>-Press: Moving-&gt;UP, Release: Call short button</p> <p>-Press: Moving-&gt;DOWN, Release: Call short button</p> <p>-Press: Moving-&gt;Toggle, Release: Call short button</p>	<p><b>Invalid:</b> no action when long press the button</p> <p><b>Stepping-&gt;Increase/Stop:</b> when long press the button, it will increase/stop the angle of louver.</p> <p><b>Stepping-&gt;Decrease/Stop:</b> when long press the button, it will decrease/stop the angle of louver.</p> <p><b>Stepping-&gt; Toggle/Stop:</b> when long press the button, it will toggle/stop the angle of louver.</p> <p><b>Moving-&gt; UP:</b> When long press the button, it will send move up telegram</p> <p><b>Moving-&gt; Down:</b> When long press the button, the shutter will move down</p> <p><b>Moving-&gt; Toggle:</b> When long press the button, it will send move down telegram</p> <p><b>Press: Moving-&gt;UP, Release: Call short button:</b> When long press the button, it will send move up telegram; when release, it will send the value of short button.</p> <p><b>Press: Moving-&gt;DOWN, Release: Call short button:</b> When long press the button, it will send move down telegram; when release, it will send the value of short button.</p> <p><b>Press: Moving-&gt;Toggle, Release: Call short button:</b> When long press the button, it will send move up/down telegram; when release, it will send the value of short button.</p>



68	Long button time after	0.2s..(1s)..60s	Set time for long-press, define the long press by end-user
69	Delay for Stepping of shutter(0..255s)	(0)..255	Set the delay time for adjusting the angle of louver
70	Delay for Moving of shutter(0..255s)	(0)..255	Set the delay time for the shutter moving.
71	Stepping telegram repeated enable	(Disable), Enable	Whether repeat sendingadjusting telegram. <b>Disable:</b> do not repeat sendingadjusting telegram. <b>Enable:</b> it will repeat sending the adjusting telegram.
72	Stepping telegram repeated time	0.2s..(0.3s)..60s	The interval of sending adjusting telegram
73	Stepping telegram repeated number (1..255,0-unlimited)	(0)..255	The repeat times of sending adjusting telegram
74	Moving stopped telegram enabled (Adjust telegram used for stop)	(Disable), Enable	Enable/disable the function to auto stop the shutter after moving
75	Moving stopped telegram delay time: base	100ms...1sec..1hour	These two parameters are used to set thedelay time to stop the shutter after moving, the delay time = base*factor.
76	Factor[1..255]->time=base*factor	1..(10)...255	These two parameters are used to set thedelay time to stop the shutter after moving, the delay time = base*factor.
77	The operation time interval: base	(10ms)..1hour	These two parameters are used to set the time interval of repeat operation, the time interval = base*factor.
78	Factor[1..255]->time=base*factor	(1)...255	These two parameters are used to set the time interval of repeat operation, the time interval = base*factor.

2.1.1.4_Flexible controller
-----------------------------

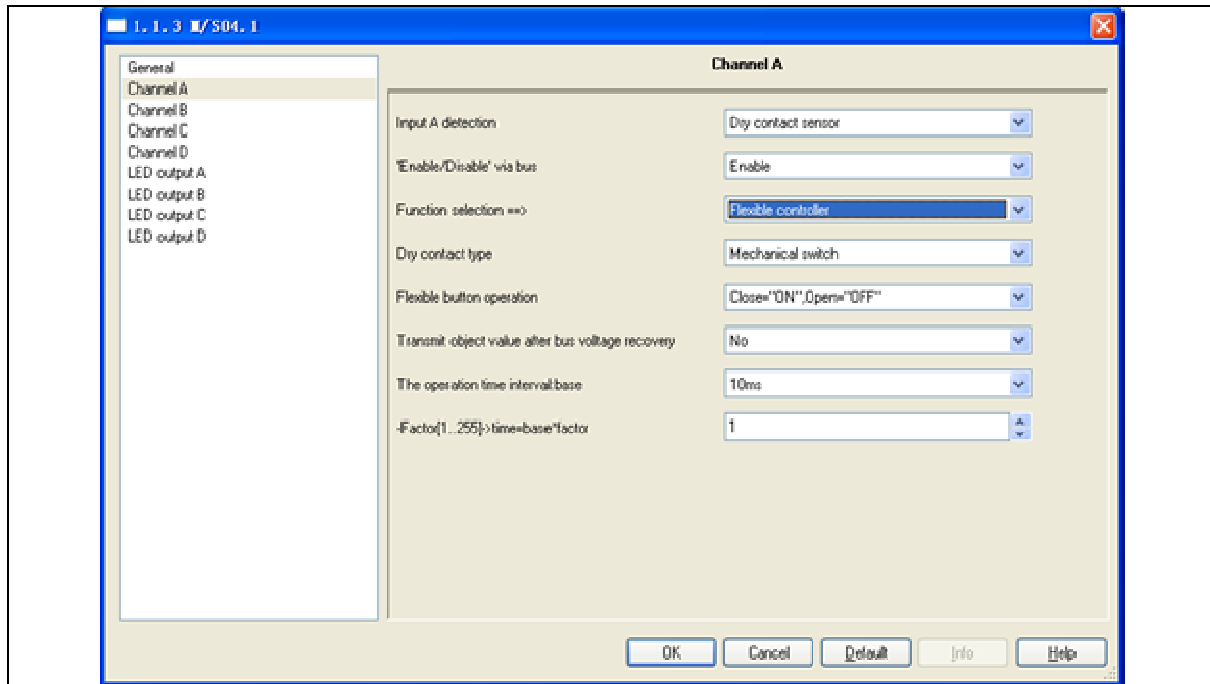

No.	ETS-Parameter	Range (default)	Description
79	Dry contact type	-(Mechanical switch) -Electronic switch	<i>Function selection</i>
<b>2.1.1.4.1 Mechanical switch</b>			
80	Flexible button operation	-Invalid -(Close="toggle") -Open="toggle" -Close="ON" -Open="ON" -Close="ON", Open="ON" -Close="OFF" -Open="OFF" -Close="OFF", Open="OFF" -Close="ON", Open="OFF" -Close="OFF", Open="ON"	<b>Invalid:</b> the dry contact is invalid. <b>Close="Toggle":</b> when closing, it will invert the last time's value then send it out <b>Open="Toggle":</b> when opening, it will invert the last time's value then send it out <b>Close="ON":</b> when closing, the value it will send is 1 <b>Open="ON":</b> when opening, the value it will send is 1 <b>Close="ON", Open="ON":</b> the value it will send is always 1 <b>Close="OFF":</b> when closing, the value it will send is 0 <b>Open="OFF":</b> when opening, the value it will send is 0 <b>Close="OFF", Open="OFF":</b> the value it will send is always 0 <b>Close="ON", Open="OFF":</b> when closing, the value it will send is 1; when opening, the value it will send is 0 <b>Close="OFF", Open="ON":</b> when closing, the value it will send is 0; when opening, the value it will send is 1
81	Transmit object value after bus	-(NO)	<i>Whether transmit object</i>

	voltage recovery	-YES	<i>value after bus voltage recovery.</i> <b>NO:</b> do not transmit object value after bus voltage recovery. <b>YES:</b> will transmit object value after bus voltage recovery.
82	The operation time interval: base	(10ms)..1hour	<i>These two parameters are used to set the time interval of repeat operation, the time interval = base*factor.</i>
83	Factor[1..255]->time=base*factor	(1)...255	<i>These two parameters are used to set the time interval of repeat operation, the time interval = base*factor.</i>
<b>2.1.1.4.2 Electronic switch</b>			
84	The normally contact status is	Closed/(Open)	<i>Set the dry contact's normal status when have no operation.</i> <b>Close:</b> the contact's normal status is closed. <b>Open:</b> the contact's normal status is open.
85	Flexible button operation	Invalid -(Press="toggle") Release="toggle" Press ="ON" Release ="ON" Press ="ON", Release ="ON" Press ="OFF" Release ="OFF" Press ="OFF", Release ="OFF" Press ="ON", Release ="OFF" Press ="OFF", Release ="ON"	<b>Invalid:</b> the dry contact is invalid. <b>Press="Toggle":</b> when press, it will invert the last time's value then send itout <b>Release="Toggle":</b> when release, it will invert the last time's value then send itout <b>Press ="ON":</b> when press, the value it will send is 1 <b>Release ="ON":</b> when release, the value it will send is 1 <b>Press="ON", Release ="ON":</b> the value it will send is always 1 <b>Press="OFF":</b> when press, the value it will send is 0 <b>Release="OFF":</b> when release, the value it will send is 0 <b>Press=" OFF", Release=" OFF":</b> the value it will send is always 0 <b>Press=" ON", Release=" OFF":</b> when press, the value it will send is 1; when release, the value it will send is 0 <b>Press=" OFF", Release=" ON":</b> when press, the value it will send is 0; when release, the value it will send is 1
86	The operation time interval:	(10ms)..1hour	<i>These two parameters are</i>

	base		used to set the time interval of repeat operation, the time interval = base*factor.
87	Factor[1..255]->time=base*factor	(1)...255	These two parameters are used to set the time interval of repeat operation, the time interval = base*factor.

2.1.1.5\_Scene controller

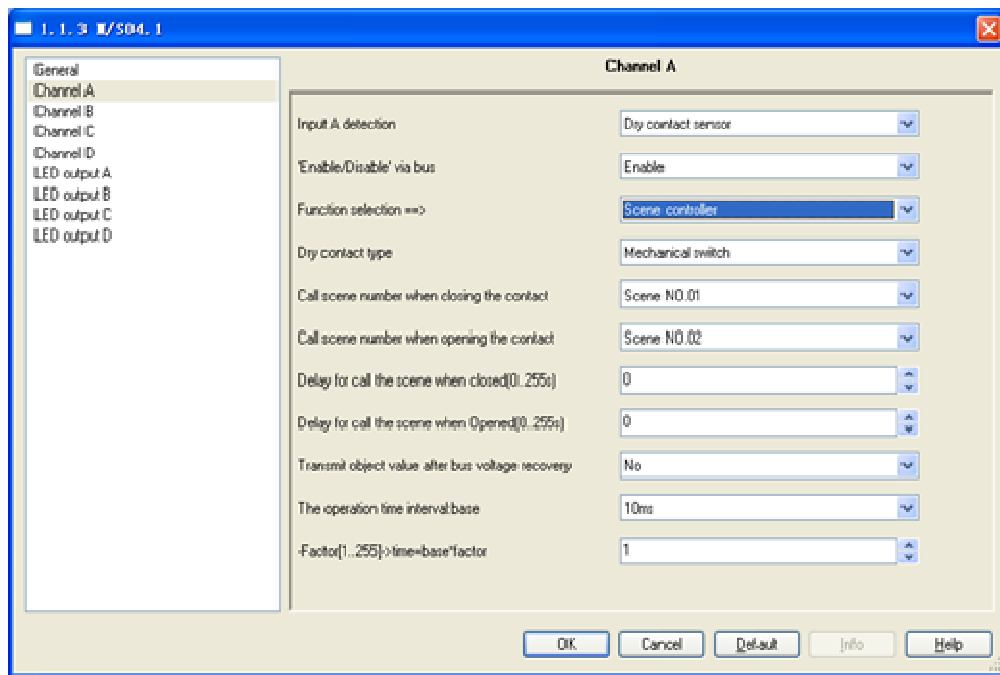

No.	ETS-Parameter	Range (default)	Description
88	Dry contact type	-(Mechanical switch) -Electronic switch	Function selection
<b>2.1.1.5.1 Mechanical switch</b>			
89	Call scene number when closing the contact	Invalid, (Scene NO.01)..Scene NO.64	Call corresponding scene when closing
90	Call scene number when opening the contact	Invalid..(Scene NO.02)..Scene NO.64	Call corresponding scene when opening
91	Delay for call the scene when closed (0...255s)	(0)..255	Set the delay time to call scene when closing
92	Delay for call the scene when Opened (0...255s)	(0)..255	Set the delay time to call scene when opening
93	Transmit object value after bus	-(NO)	Whether transmit object

	voltage recovery	-YES	<i>value after bus voltage recovery.</i> <b>NO:</b> do not transmit object value after bus voltage recovery. <b>YES:</b> will transmit object value after bus voltage recovery.
94	The operation time interval: base	(10ms)..1hour	<i>These two parameters are used to set the time interval of repeat operation, the time interval = base*factor.</i>
95	Factor[1..255]->time=base*factor	(1)..255	<i>These two parameters are used to set the time interval of repeat operation, the time interval = base*factor.</i>
<b>2.1.1.5.2 Electronic switch</b>			
96	The normally contact status is	Closed/(Open)	<i>Set the dry contact's normal status when have no operation.</i> <b>Close:</b> the contact's normal status is closed. <b>Open:</b> the contact's normal status is open.
97	Call scene when short button operation	Scene NO.01..Scene NO.24	<i>Call corresponding scene when short press</i>
98	Reaction when long button operation	-(Scene dimming) -Scene saving -Dimming and saving	<i>Set long press's control function</i> <b>Scene dimming:</b> will dim the scene when long press <b>Scene saving:</b> will save current value to the scene when long press <b>Dimming and saving:</b> will dim the scene and save the last dimming value to the scene when long press
99	-Scene dimming	-(Dim-> Brighter) -Dim-> Darker -Dim-> Brighter/Darker	<b>Dim-&gt;Brighter:</b> will increase the scene's brightness when long press <b>Dim-&gt;Darker:</b> will decrease the scene's brightness when long press <b>Dim-&gt; Brighter/Darker:</b> will increase/decrease the scene's brightness when long press
100	Long button time after	0.2s..(1s)..60s	<i>Set time for long-press, define the long press by end-user</i>
101	Short button operation toggled	-(NO) -YES	<i>Enable/disable the toggle function for short press</i>
102	-Toggled scene of the short operation	Scene NO.01, (Scene NO.02)..Scene NO.24	<i>Call another scene when short press, toggle between two of them</i>
103	Delay for Call the scene(0..255s)	(0)..255	<i>Set the delay time to call scene</i>
104	The operation time interval:	(10ms)..1hour	<i>These two parameters are</i>

	base		used to set the time interval of repeat operation, the time interval = base*factor.
105	Factor[1..255]->time=base*factor	(1)...255	These two parameters are used to set the time interval of repeat operation, the time interval = base*factor.

2.1.1.6\_Sequence controller

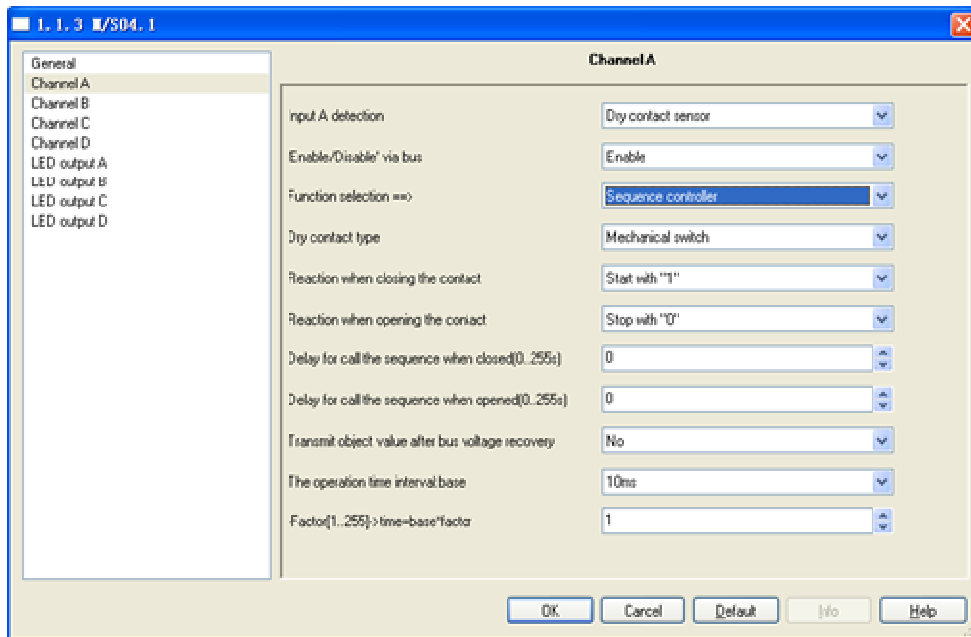

No.	ETS-Parameter	Range (default)	Description
106	Dry contact type	-(Mechanical switch) -Electronic switch	Function selection

2.1.1.6.1\_Mechanical switch

107	Reaction when closing the contact	-Invalid -Toggle -(Start with "1") -Stop with "0"	Set the function of the dry contact when closing it. <b>Invalid:</b> the dry contact is invalid. <b>Toggle:</b> It will invert the last time's value then send it out when closing <b>Start with "1"</b> : The value it will send is 1 to start the sequence. <b>Stop with "0"</b> : The value it will send is 1 to stop the sequence.
108	Reaction when opening the contact	-Invalid -Toggle -Start with "1" -(Stop with "0")	Set the function of the dry contact when opening it. <b>Invalid:</b> the dry contact is invalid.

			<p><b>Toggle:</b> It will invert the last time's value then send it out when opening</p> <p><b>Start with "1":</b> The value it will send is 1 to start the sequence.</p> <p><b>Stop with "0":</b> The value it will send is 0 to stop the sequence.</p>
109	Delay for call the sequence when closed(0..255s)	(0)..255	Set the delay time to call the sequence after closing
110	Delay for call the sequence when opened(0..255s)	(0)..255	Set the delay time to call the sequence after opening
111	Transmit object value after bus voltage recovery	-(NO) -YES	<p>Whether transmit object value after bus voltage recovery.</p> <p><b>NO:</b> do not transmit object value after bus voltage recovery.</p> <p><b>YES:</b> will transmit object value after bus voltage recovery.</p>
112	The operation time interval: base	(10ms)..1hour	These two parameters are used to set the time interval of repeat operation, the time interval = base*factor.
113	Factor[1..255]- >time=base*factor	(1)..255	These two parameters are used to set the time interval of repeat operation, the time interval = base*factor.
<b>2.1.1.6.2 Electronic switch</b>			
114	The normally contact status is	Closed/(Open)	Set the dry contact's normal status when have no operation.
115	Reaction when short button operation	<p>-Invalid</p> <p>-(Toggle)</p> <p>-Start with "1"</p> <p>-Stop with "0"</p>	<p><b>Invalid:</b> the dry contact is invalid.</p> <p><b>Toggle:</b> It will invert the last time's value then send it out when short press</p> <p><b>Start with "1":</b> The value it will send is 1 to start the sequence.</p> <p><b>Stop with "0":</b> The value it will send is 0 to stop the sequence.</p>
116	Reaction when long button operation	<p>-(Invalid)</p> <p>-(Toggle)</p> <p>-Start with "1"</p> <p>-Stop with "0"</p>	<p><b>Invalid:</b> the dry contact is invalid.</p> <p><b>Toggle:</b> It will invert the last time's value then send it out when long press</p> <p><b>Start with "1":</b> The value it will send is 1 to start the sequence.</p> <p><b>Stop with "0":</b> The value it will send is 0 to stop the sequence.</p>

117	Long button time after	0.2s..(1s)..60s	Set time for long-press, define the long press by end-user
118	Delay for short operation(0..255s)	(0)..255	Set the delay time to send out telegram for short press
119	Delay for long operation(0..255s)	(0)..255	Set the delay time to send out telegram for long press
120	The operation time interval: base	(10ms)..1hour	These two parameters are used to set the time interval of repeat operation, the time interval = base*factor.
121	Factor[1..255]->time=base*factor	(1)..255	These two parameters are used to set the time interval of repeat operation, the time interval = base*factor.

2.1.1.7\_Percentage controller

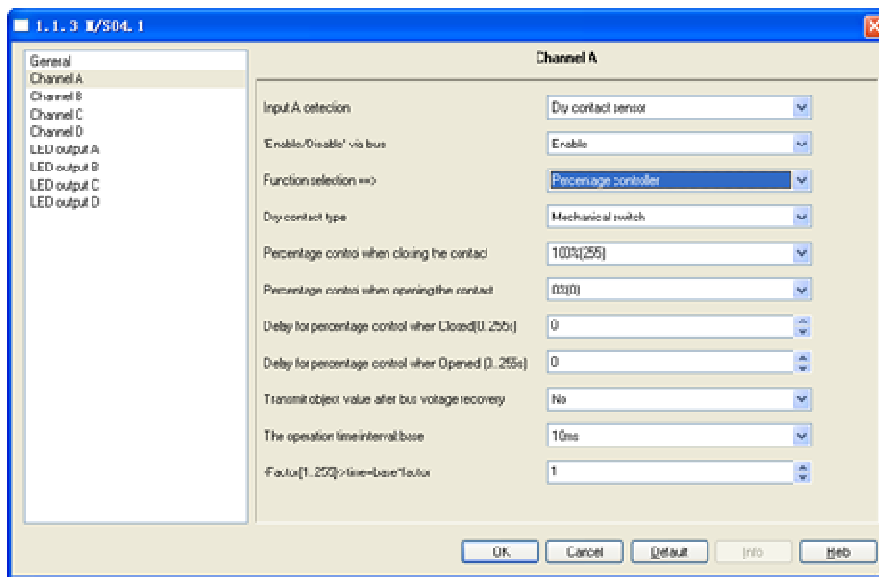

No.	ETS-Parameter	Range (default)	Description
122	Dry contact type	-(Mechanical switch) -Electronic switch	Function selection
<b>2.1.1.7.1 Mechanical switch</b>			
123	Percentage control when closing the contact	-Invalid -0%(0)..(100%(255))	Set the percentage value when closing the dry contact <b>Invalid:</b> the dry contact is invalid. <b>0%(0)—100%(255) :</b> the specific percentage value
124	Percentage control when opening the contact	-Invalid -(0%(0))..100%(255)	Set the percentage value when closing the dry contact <b>Invalid:</b> the dry contact is invalid. <b>0%(0)—100%(255) :</b> the



			<i>specific percentage value</i>
125	Delay for percentage control when Closed (0..255s)	(0)..255	<i>Set the delay time to send out telegram when closing</i>
126	Delay for percentage control when Opened (0..255s)	(0)..255	<i>Set the delay time to send out telegram when opening</i>
127	Transmit object value after bus voltage recovery	-(NO) -YES	<i>Whether transmit object value after bus voltage recovery. <b>NO:</b> do not transmit object value after bus voltage recovery. <b>YES:</b> will transmit object value after bus voltage recovery.</i>
128	The operation time interval: base	(10ms)..1hour	<i>These two parameters are used to set the time interval of repeat operation, the time interval = base*factor.</i>
129	Factor[1..255]- >time=base*factor	(1)..255	<i>These two parameters are used to set the time interval of repeat operation, the time interval = base*factor.</i>
<b>2.1.1.7.2 Electronic switch</b>			
130	The normally contact status is	Closed/(Open)	<i>Set the dry contact's normal status when have no operation. <b>Close:</b> the contact's normal status is closed. <b>Open:</b> the contact's normal status is open.</i>
131	Reaction when short button operation	-Invalid -0%(0)..(100%(255))	<i><b>Invalid:</b> short press is invalid. <b>0%(0)—100%(255)</b> : the specific percentage value</i>
132	Reaction when long button operation	-Invalid -0%(0)..(100%(255))	<i><b>Invalid:</b> long press is invalid. <b>0%(0)—100%(255)</b> : the specific percentage value</i>
133	Long button time after	0.2s..(1s)..60s	<i>Set time for long-press, define the long press by end-user</i>
134	Short button operation toggled	-(NO) -YES	<i>Enable/disable the toggle function for short press</i>
135	Toggled brightness of the short operation	-(0%(0)..100%(255))	<i>Send another percentage value when short press, toggle between two of them</i>
136	Long button operation toggled	-(NO) -YES	<i>Enable/disable the toggle function for long press</i>
137	Toggled brightness of the long operation	-(0%(0)..100%(255))	<i>Send another percentage value when long press, toggle between two of them</i>
138	Delay for short operation (0..255s)	(0)..255	<i>Set the delay time to send out telegram for short press</i>
139	Delay for long operation (0..255s)	(0)..255	<i>Set the delay time to send out telegram for long press</i>
140	The operation time interval: base	(10ms)..1hour	<i>These two parameters are used to set the time interval of repeat operation, the time</i>

			<i>interval = base*factor.</i>
141	Factor[1..255]- >time=base*factor	(1)...255	<i>These two parameters are used to set the time interval of repeat operation, the time interval = base*factor.</i>

2.1.1.8\_Threshold controller

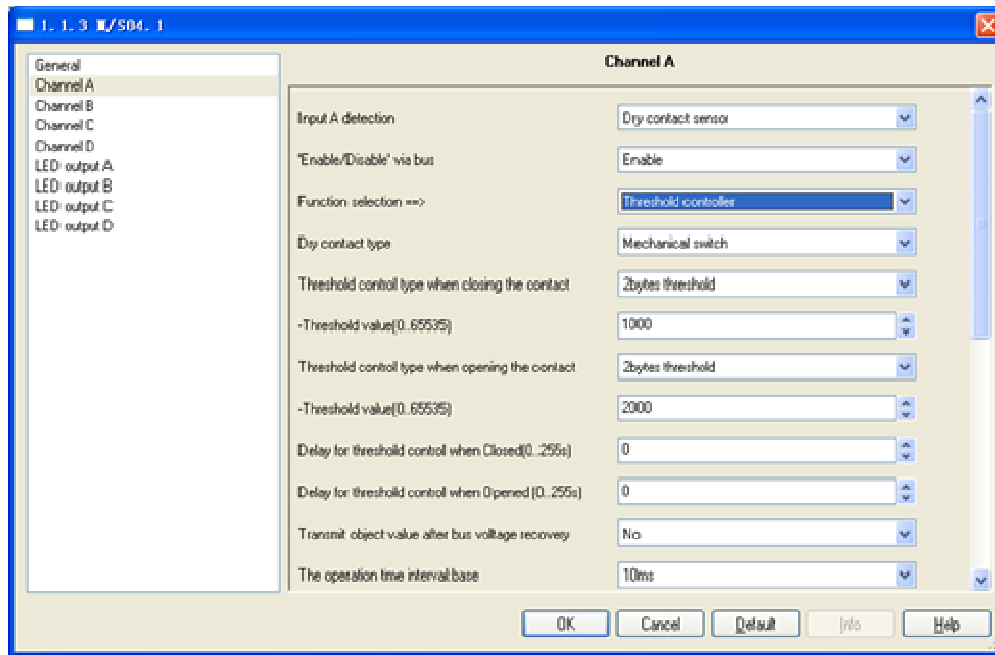

No.	ETS-Parameter	Range (default)	Description
142	Dry contact type	-(Mechanical switch) -Electronic switch	<i>Function selection</i>
<b>2.1.1.8.1_Mechanical switch</b>			
143	Threshold control type when closing the contact	-Invalid -(1byte threshold) -2bytes threshold	<i>Select the threshold type when closing</i>
144	Threshold value(0..255)	(0)..255	<i>Set the threshold value of 1byte</i>
145	Threshold value(0..65535)	(0)..65535	<i>Set the threshold value of 2byte</i>
146	Delay for threshold control when Closed (0..255s)	(0)..255	<i>Set the delay time to send the threshold value when closing</i>
147	Delay for threshold control when Opened (0..255s)	(0)..255	<i>Set the delay time to send the threshold value when opening</i>
148	Transmit object value after bus voltage recovery	-(NO) -YES	<i>Whether transmit object value after bus voltage recovery. <b>NO:</b> do not transmit object value after bus voltage recovery. <b>YES:</b> will transmit object value after bus voltage recovery.</i>
149	The operation time interval:	(10ms)..1hour	<i>These two parameters are</i>

	base		used to set the time interval of repeat operation, the time interval = base*factor.
150	Factor[1..255]- >time=base*factor	(1)..255	These two parameters are used to set the time interval of repeat operation, the time interval = base*factor.
<b>2.1.1.8.2_Electronic switch</b>			
151	The normally contact status is	Closed/(Open)	Set the dry contact's normal status when have no operation. <b>Close:</b> the contact's normal status is closed. <b>Open:</b> the contact's normal status is open.
152	Reaction when short button operation	-Invalid -(1byte threshold) -2bytes threshold	Select the threshold type for short press
153	Threshold value(0..255)	(0)..255	Set the threshold value of 1byte
154	Threshold value(0..65535)	(0)..65535	Set the threshold value of 2byte
155	Reaction when long button operation	-Invalid -(1byte threshold) -2bytes threshold	Select the threshold type for long press
156	Threshold value(0..255)	(0)..255	Set the threshold value of 1byte
157	Threshold value(0..65535)	(0)..65535	Set the threshold value of 2byte
158	Long button time after	0.2s..(1s)..60s	Set time for long-press, define the long press by end-user
159	Short button operation toggled	-(NO) -YES	Enable/disable the toggle function for short press
160	Toggled threshold(0..255) of the short operation	(0)..255	Send another threshold value when short press, toggle between two of them
161	Toggled threshold(0..255) of the short operation	(0)..65535	Send another threshold value when short press, toggle between two of them
162	Long button operation toggled	-(NO) -YES	Enable/disable the toggle function for long press
163	Toggled threshold(0..255) of the long operation	(0)..255	Send another threshold value when long press, toggle between two of them
164	Toggled threshold(0..65535) of the long operation	(0)..65535	Send another threshold value when long press, toggle between two of them
165	Delay for short operation (0..255s)	(0)..255	Set the delay time to send the threshold value for short press
166	Delay for long operation (0..255s)	(0)..255	Set the delay time to send the threshold value for long press
167	The operation time interval: base	(10ms)..1hour	These two parameters are used to set the time interval of repeat operation, the time interval = base*factor.

	Factor[1..255]->time=base*factor	(1)...255	These two parameters are used to set the time interval of repeat operation, the time interval = base*factor.
--	----------------------------------	-----------	--

2.1.1.9\_String(14bytes) controller

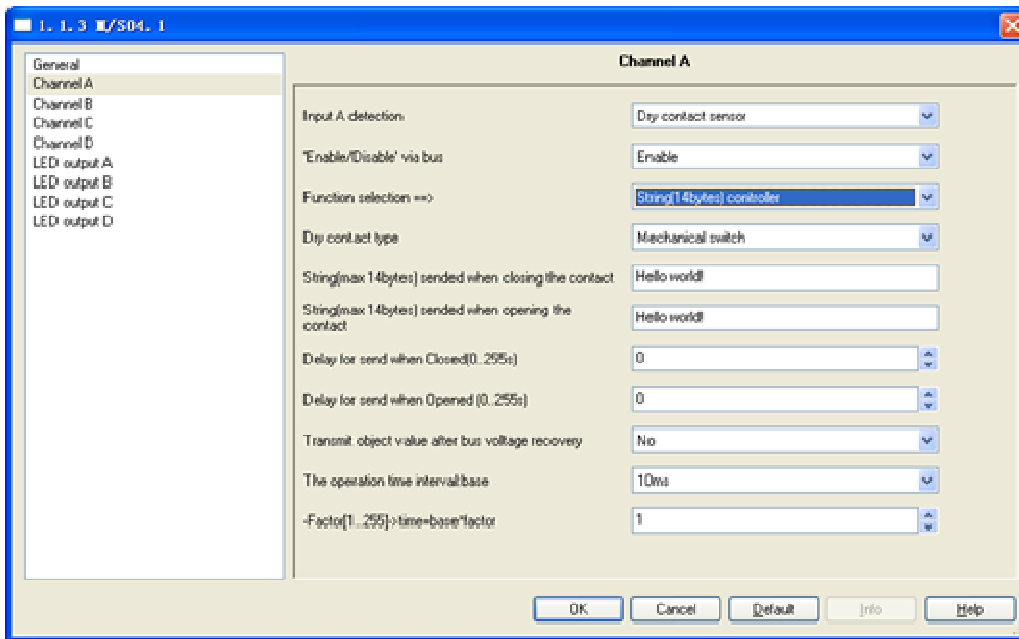

No.	ETS-Parameter	Range (default)	Description
168	Dry contact type	-(Mechanical switch) -Electronic switch	Function selection
<b>2.1.1.9.1_Mechanical switch</b>			
169	String(max 14bytes) sent when closing the contact	(Hello world!)	Set the string to send when closing the dry contact. The stringMax. length is 14bytes
170	String(max 14bytes) sent when opening the contact	(Hello world!)	Set the string to send when opening the dry contact. The stringMax. length is 14bytes
171	Delay for send when Closed (0..255s)	(0)..255	Set the delay time to send string when closing
172	Delay for send when Opened (0..255s)	(0)..255	Set the delay time to send string when opening
173	Transmit object value after bus voltage recovery	-(NO) -YES	Whether transmit object value after bus voltage recovery. <b>NO:</b> do not transmit object value after bus voltage recovery. <b>YES:</b> will transmit object value after bus voltage recovery.
174	The operation time interval: base	(10ms)..1hour	These two parameters are used to set the time interval

			<i>of repeat operation, the time interval = base*factor.</i>
175	Factor[1..255]- >time=base*factor	(1)...255	<i>These two parameters are used to set the time interval of repeat operation, the time interval = base*factor.</i>
<b>2.1.1.9.2_Electronic switch</b>			
176	The normally contact status is	Closed/(Open)	<i>Set the dry contact's normal status when have no operation. <b>Close:</b> the contact's normal status is closed. <b>Open:</b> the contact's normal status is open.</i>
177	String(max 14bytes) sende when short button operation	(Hello world!)	<i>Set the string to send when short press the dry contact.</i>
178	String(max 14bytes) sende when long button operation	(Hello world!)	<i>Set the string to send when long press the dry contact</i>
179	Long button time after	0.2s..(1s)..60s	<i>Set time for long-press, define the long press by end-user</i>
180	Delay for short operation (0..255s)	(0)..255	<i>Set the delay time to send string for short press</i>
181	Delay for long operation (0..255s)	(0)..255	<i>Set the delay time to send string for long press</i>
182	The operation time interval: base	(10ms)..1hour	<i>These two parameters are used to set the time interval of repeat operation, the time interval = base*factor.</i>
183	Factor[1..255]- >time=base*factor	(1)...255	<i>These two parameters are used to set the time interval of repeat operation, the time interval = base*factor.</i>

<b>2.1.1.10_Forced position controller</b>
--

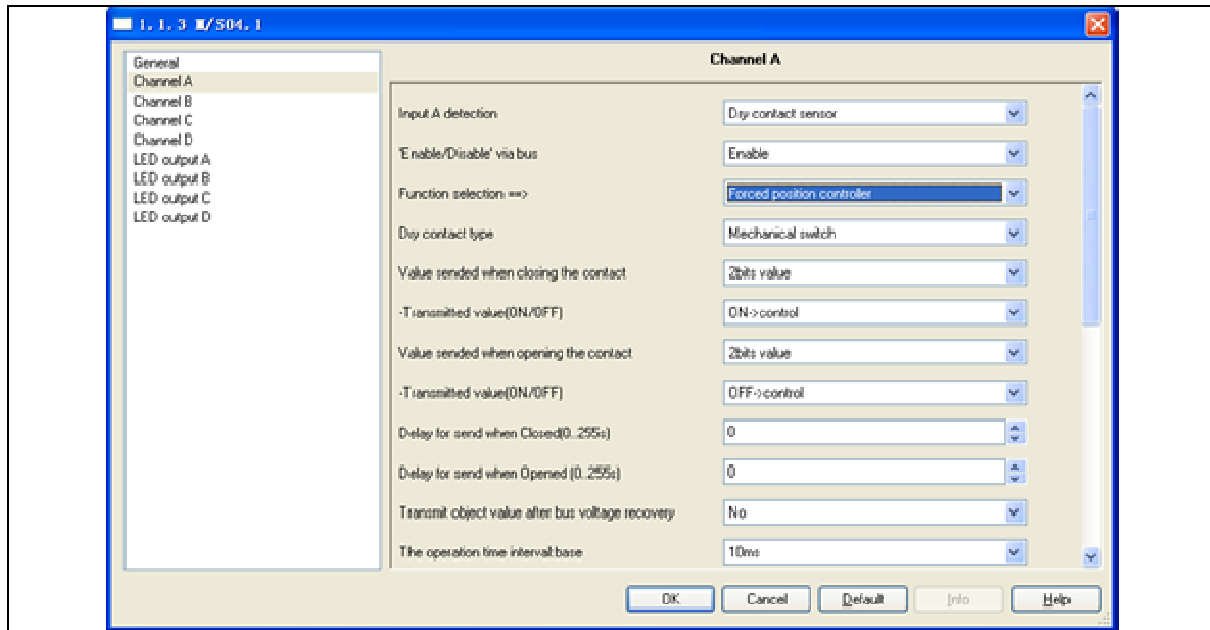

No.	ETS-Parameter	Range (default)	Description
184	Dry contact type	-(Mechanical switch) -Electronic switch	Function selection
<b>2.1.1.10.1 Mechanical switch</b>			
185	Value send when closing the contact	-Invalid -(2bits value) -1byte value(0..255) -2bytes value(-32768..32767) -2bytes value(0..65536) -2bytes value(Float) -4bytes value(0..2147483647)	Set the value type to send when closing the dry contact.
186	-Transmitted value (ON/OFF)	-(ON->control) -OFF->control -No control	Set the control type of 2 bit when closing: ON, OFF, No Control
187	-Transmitted value (0.255)	(0)..255	Set the transmitted value of 1 byte when closing
188	-Transmitted value(-32768..32767)	-32768..(0)..32767	Set the transmitted value of 2 byte when closing
189	-Transmitted value(0-65535)	(0)..65536	Set the transmitted value of 2 byte when closing
190	-Transmitted value	-100..(0)..100	Set the transmitted value of 2 byte when closing
191	-Transmitted value(0..2147483647)	(0)..2147483647	Set the transmitted value of 4 byte when closing
192	Value send when opening the contact	-Invalid -(2bits value) -1byte value(0..255) -2bytes value(-32768..32767) -2bytes value(0..65536) -2bytes value(Float) -4bytes value(0..2147483647)	Set the value type to send when opening the dry contact.
193	-Transmitted value (ON/OFF)	-(ON->control) -(OFF->control) -No control	Set the control type of 2 bit when closing: ON, OFF, No Control
194	-Transmitted value (0.255)	(0)..255	Set the transmitted value of 1

			<i>byte when closing</i>
195	-Transmitted value(-32768..32767)	-32768..(0)..32767	<i>Set the transmitted value of 2 byte when closing</i>
196	-Transmitted value(0-65535)	(0)..65536	<i>Set the transmitted value of 2 byte when closing</i>
197	-Transmitted value	-100..(0)..100	<i>Set the transmitted value of 2 byte when closing</i>
198	-Transmitted value(0..2147483647)	(0)..2147483647	<i>Set the transmitted value of 4 byte when closing</i>
199	Delay for send when Closed (0..255s)	(0)..255	<i>Set the delay time to send the value when closing</i>
200	Delay for send when Opened (0..255s)	(0)..255	<i>Set the delay time to send the value when opening</i>
201	Transmit object value after bus voltage recovery	-(NO) -YES	<i>Whether transmit object value after bus voltage recovery. <b>NO:</b> do not transmit object value after bus voltage recovery. <b>YES:</b> will transmit object value after bus voltage recovery.</i>
202	The operation time interval: base	(10ms)..1hour	<i>These two parameters are used to set the time interval of repeat operation, the time interval = base*factor.</i>
203	Factor[1..255]->time=base*factor	(1)...255	<i>These two parameters are used to set the time interval of repeat operation, the time interval = base*factor.</i>
<b>2.1.1.10.2_Electronic switch</b>			
204	The normally contact status is	Closed/(Open)	<i>Set the dry contact's normal status when have no operation. <b>Close:</b> the contact's normal status is closed. <b>Open:</b> the contact's normal status is open.</i>
205	Value when short button operation	-Invalid -(2bits value) -1byte value(0..255) -2bytes value(-32768..32767) -2bytes value(0..65536) -2bytes value(Float) -4bytes value(0..2147483647)	<i>Set the value type to send when short press</i>
206	-Transmitted value (ON/OFF)	-(ON->control) -OFF->control -No control	<i>Set the control type of 2 bit when closing: ON, OFF, No Control</i>
207	-Transmitted value (0.255)	(0)..255	<i>Set the transmitted value of 1 byte when closing</i>
208	-Transmitted value(-32768..32767)	-32768..(0)..32767	<i>Set the transmitted value of 2 byte when closing</i>
209	-Transmitted value(0-65535)	(0)..65536	<i>Set the transmitted value of 2</i>

			<i>byte when closing</i>
210	-Transmitted value	-100..(0)..100	<i>Set the transmitted value of 2 byte when closing</i>
211	-Transmitted value(0..2147483647)	(0)..2147483647	<i>Set the transmitted value of 4 byte when closing</i>
212	Value when long button operation	-Invalid -(2bits value) -1byte value(0..255) -2bytes value(-32768..32767) -2bytes value(0..65536) -2bytes value(Float) -4bytes value(0..2147483647)	<i>Set the value type to send when short press</i>
213	Long button time after	0.2s..(1s)..60s	<i>Set time for long-press, define the long press by end-user</i>
214	Delay for short operation (0..255s)	(0)..255	<i>Set the delay time to send the value for short press</i>
215	Delay for long operation (0..255s)	(0)..255	<i>Set the delay time to send the value for long press</i>
216	The operation time interval: base	(10ms)..1hour	<i>These two parameters are used to set the time interval of repeat operation, the time interval = base*factor.</i>
217	Factor[1..255]->time=base*factor	(1)...255	<i>These two parameters are used to set the time interval of repeat operation, the time interval = base*factor.</i>

2.1.1.11\_Counter controller

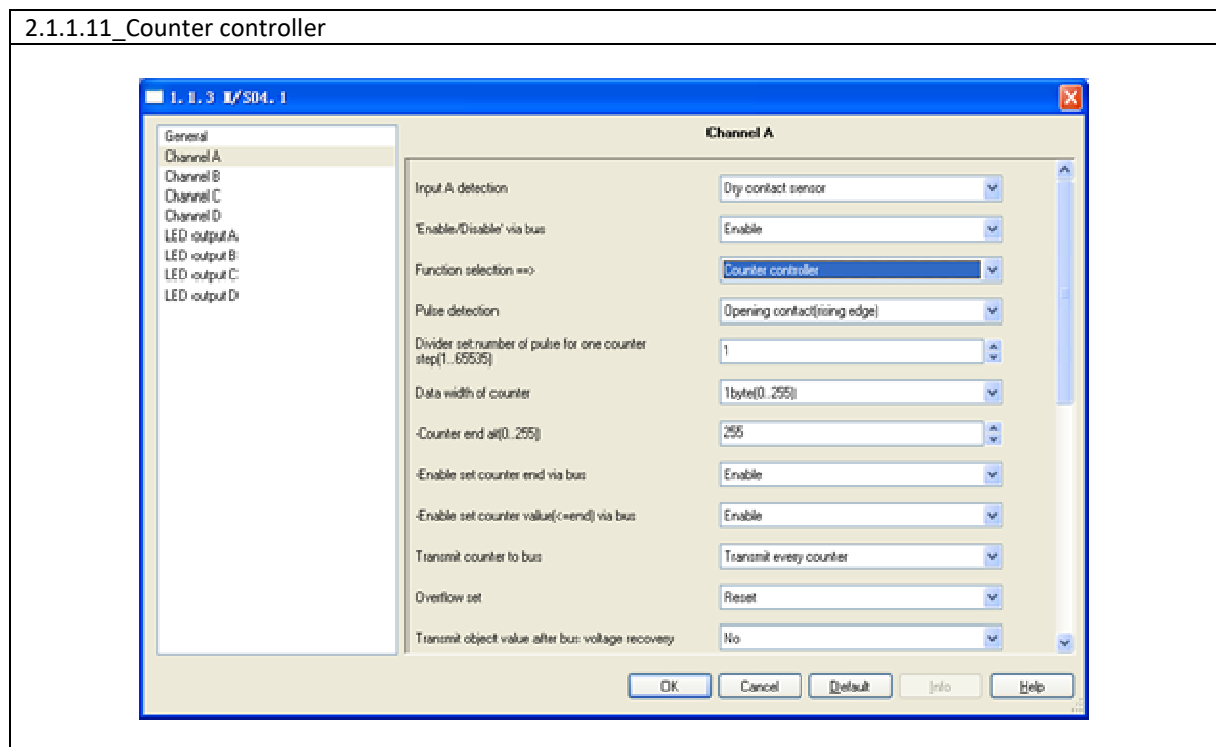



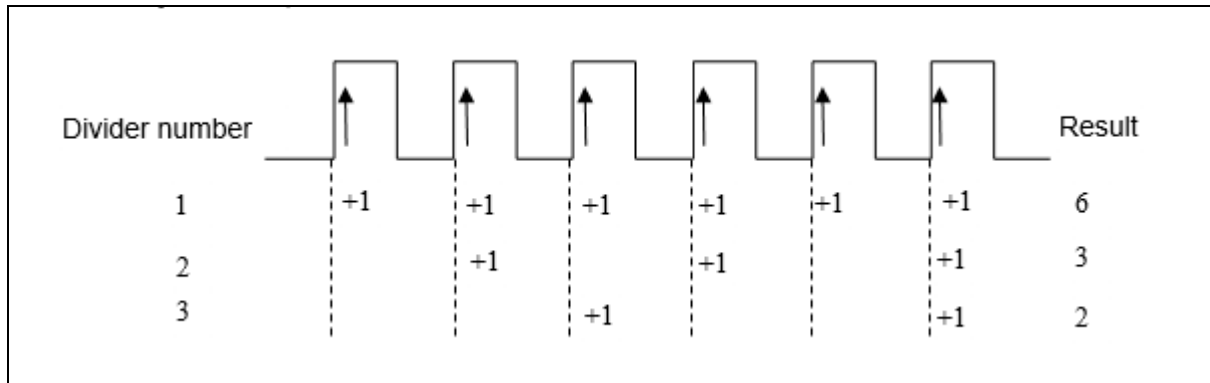

No.	ETS-Parameter	Range (default)	Description
218	Pulse detection	-Closing contact (falling edge) -Opening contact (rising edge) -Closing (falling edge) and Opening (rising edge)	<b>Closing contact (falling edge):</b> take as pulse when detecting the falling edge <b>Opening contact (rising edge):</b> take as pulse when detecting the rising edge <b>Closing (falling edge) and Opening (rising edge):</b> take as pulse when detecting the falling/rising edge
219	Divider set: number of pulse for one counter step (1..65535)	(1)..65535	Set the number of pulses for one counter
220	Data width of counter	-1byte value(0..255) -2bytes value(0..65536) -4bytes value(0..2147483647)	Set the data width for the counter
221	-Counter end at (0..255)	0..(255)	Set the end of the counter
222	-Counter end at (0..65535)	0..(65535)	Set the end of the counter
223	-Counter end at (0..2147483647)	0..(100000)..2147483647	Set the end of the counter
224	-Enable set counter end via bus	-(Disable) -Enable	Whether set the end of the counter via bus. Enable: you can set the end of the counter via bus Disable: you can't set the end of the counter via bus
225	-Enable set counter value (<=end) via bus	-(Disable) -Enable	Whether set the starting counter via bus. Enable: you can set the starting counter via bus. Disable: you can't set the starting counter via bus.
226	Transmit counter to bus	-Don't transmission -(Transmit every counter) -Transmit counter cyclically	<b>Don't transmission:</b> don't transmit any counter to bus. <b>Transmit every counter:</b> transmit every counter to bus <b>Transmit counter cyclically:</b> transmit the counter to bus cyclically
227	-Counter value transmitted time: base	-(1sec) -1min -1hour	These two parameters are used to set the time interval of transmission, the time interval = base*factor.

228	Factor[1..255]- >time=base*factor	(1)...255	<i>These two parameters are used to set the time interval of transmission, the time interval = base*factor.</i>
229	Counter Transmitted number (1..255, 0-unlimited)	(0)..255	<i>Set the number of the counter to transmit</i>
230	Overflow set	- (Reset) - Reset and Alarm - Stop - Stop and Alarm	<b>Reset:</b> will reset the counter when overflow. <b>ResetandAlarm:</b> will reset the counter and alarm when overflow <b>Stop:</b> will stop the counter when overflow. <b>Stopand Alarm:</b> will stop the counter and alarm when overflow.
231	Transmit object value after bus voltage recovery	- (NO) - YES	<i>Whether transmit object value after bus voltage recovery.</i> <b>NO:</b> do not transmit object value after bus voltage recovery. <b>YES:</b> it will transmit object value after bus voltage recovery.
232	The operation time interval: base	(10ms)..1hour	<i>These two parameters are used to set the time interval of repeat operation, the time interval = base*factor.</i>
233	Factor[1..255]- >time=base*factor	(1)...255	<i>These two parameters are used to set the time interval of repeat operation, the time interval = base*factor.</i>

2.1.1.12_ Combination controller
----------------------------------

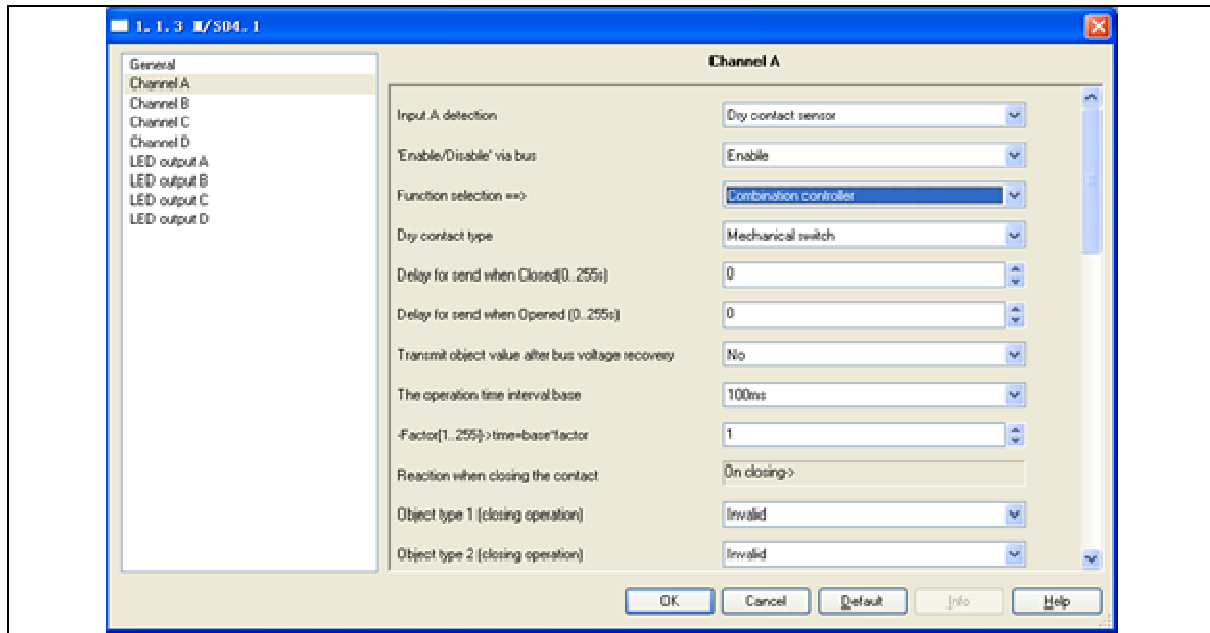

No.	ETS-Parameter	Range (default)	Description
234	Dry contact type	-(Mechanical switch) -Electronic switch	Function selection
<b>2.1.1.12.1_Mechanical switch</b>			
235	Delay for send when Closed (0..255s)	(0)..255	Set the delay time to send telegram when closing
236	Delay for send when Opened (0..255s)	(0)..255	Set the delay time to send telegram when opening
237	Transmit object value after bus voltage recovery	-(NO) -YES	Whether transmit object value after bus voltage recovery. <b>NO:</b> do not transmit object value after bus voltage recovery. <b>YES:</b> will transmit object value after bus voltage recovery.
238	The operation time interval: base	10ms..(100ms)..1hour	These two parameters are used to set the time interval of repeat operation, the time interval = base*factor.
239	Factor [1..255]->time=base*factor	(1)...255	These two parameters are used to set the time interval of repeat operation, the time interval = base*factor.
240	Object type 1-10 (closing operation)	-(Invalid) -Switch controller -Shutter controller -Scene controller -Sequence controller -Percentage controller -Threshold controller -String (14bytes) controller	it can send several control telegrams simultaneously when closing. Set the control objects' type here
241	-Switch value	-Toggle -(ON) -OFF	<b>Toggle:</b> It will invert the last time's value then send it out. <b>ON:</b> The value it will send is 1. <b>OFF:</b> The value it will send is

			0.
242	-Shutter value	-Toggle -(UP) -DOWN	<b>Toggle:</b> it will send move up/down telegram <b>UP:</b> it will send move up telegram <b>Down:</b> it will send move down telegram
243	-Scene value	-(Scene NO.01)..Scene NO.64	Set the output scene number
244	-Scene toggled	-(NO) -YES	Enable/disable the toggle function for scene control
245	-Toggled scene NO. is	-Scene NO.01..(Scene NO.02)..Scene NO.64	Set another output scene number, toggle between two of them to send out
246	-Sequence value	-Toggle -(Start) -Stop	<b>Toggle:</b> It will invert the last time's value then send it out <b>Start with "1":</b> The value it will send is 1 to start the sequence. <b>Stop with "0":</b> The value it will send is 0 to stop the sequence.
247	-Percentage value	0%(0)..(100%(255))	Set the output percentage value
248	-Brightness toggled	-(NO) -YES	Enable/disable the toggle function for percentage control
249	-Toggled brightness is	(0%(0))..100%(255)	Set another output percentage value, toggle between two of them to send out
250	-Threshold value type	-(1byte threshold) -2bytes threshold	Set the threshold control type
251	-Threshold (0..255) value	0..(255)	Set the threshold value
252	-Threshold(065535) value	0..(1000)..65535	Set the threshold value
253	-Threshold toggled	-(NO) -YES	Enable/disable the toggle function for threshold control
254	-Toggled threshold (0..255) is	0..(255)	Set another output threshold value, toggle between two of them to send out
255	-String (14bytes) value	(Hello world!)	Set the output string content
256	Object type 1-10 (opening operation)	-(Invalid) -Switch controller -Shutter controller -Scene controller -Sequence controller -Percentage controller -Threshold controller -String (14bytes) controller	it can send several control telegrams simultaneously when opening. Set the control objects' type here
257	-Switch value	-Toggle -(ON) -OFF	<b>Toggle:</b> It will invert the last time's value then send it out. <b>ON:</b> The value it will send is 1. <b>OFF:</b> The value it will send is 0.
258	-Shutter value	-Toggle	<b>Toggle:</b> it will send move

		-(UP) -DOWN	<i>up/down telegram</i> <b>UP:</b> it will send move up telegram <b>Down:</b> it will send move down telegram
259	-Scene value	-(Scene NO.01)..Scene NO.64	Set the output scene number
260	-Scene toggled	-(NO) -YES	Enable/disable the toggle function for scene control
261	-Toggled scene NO. is	-Scene NO.01..(Scene NO.02)..Scene NO.64	Set another output scene number, toggle between two of them to send out
262	-Sequence value	-Toggle -(Start) -Stop	<b>Toggle:</b> It will invert the last time's value then send it out <b>Start with "1":</b> The value it will send is 1 to start the sequence. <b>Stop with "0":</b> The value it will send is 0 to stop the sequence.
263	-Percentage value	0%(0)..(100%(255))	Set the output percentage value
264	-Brightness toggled	-(NO) -YES	Enable/disable the toggle function for percentage control
265	-Toggled brightness is	(0%(0))..100%(255)	Set another output percentage value, toggle between two of them to send out
266	-Threshold value type	-(1byte threshold) -2bytes threshold	Set the threshold control type
267	-Threshold (0..255) value	0..(255)	Set the threshold value
268	-Threshold(065535) value	0..(1000)..65535	Set the threshold value
269	-Threshold toggled	-(NO) -YES	Enable/disable the toggle function for threshold control
270	-Toggled threshold (0..255) is	0..(255)	Set another output threshold value, toggle between two of them to send out
271	-String (14bytes) value	(Hello world!)	Set the output string content
<b>2.1.1.12.2_Electronic switch</b>			
272	The normally contact status is	Closed/(Open)	Set the dry contact's normal status when have no operation. <b>Close:</b> the contact's normal status is closed. <b>Open:</b> the contact's normal status is open.
273	Long button time after	0.2s..(1s)..60s	Set time for long-press, define the long press by end-user
274	Delay for short operation (0..255s)	(0)..255	Set the delay time to send out telegram for short press
275	Delay for long operation (0..255s)	(0)..255	Set the delay time to send out telegram for long press
276	The operation time interval: base	10ms..(100ms)..1hour	These two parameters are used to set the time interval of repeat operation, the time interval = base*factor.

277	Factor[1..255]- >time=base*factor	(1)...255	<i>These two parameters are used to set the time interval of repeat operation, the time interval = base*factor.</i>
278	Object type 1-10 (short operation)	-(Invalid) -Switch controller -Shutter controller -Scene controller -Sequence controller -Percentage controller -Threshold controller -String (14bytes) controller	<i>it can send several control telegrams simultaneously when short press. Set the control objects' type here</i>
279	-Switch value	-Toggle -(ON) -OFF	<b>Toggle:</b> It will invert the last time's value then send it out. <b>ON:</b> The value it will send is 1. <b>OFF:</b> The value it will send is 0.
280	-Shutter value	-Toggle -(UP) -DOWN	<b>Toggle:</b> it will send move up/down telegram <b>UP:</b> it will send move up telegram <b>Down:</b> it will send move down telegram
291	-Scene value	-(Scene NO.01)..Scene NO.64	<i>Set the output scene number</i>
292	-Scene toggled	-(NO) -YES	<i>Enable/disable the toggle function for scene control</i>
293	-Toggled scene NO. is	-Scene NO.01..(Scene NO.02)..Scene NO.64	<i>Set another output scene number, toggle between two of them to send out</i>
294	-Sequence value	-Toggle -(Start) -Stop	<b>Toggle:</b> It will invert the last time's value then send it out <b>Start with "1":</b> The value it will send is 1 to start the sequence. <b>Stop with "0":</b> The value it will send is 0 to stop the sequence.
295	-Percentage value	0%(0)..(100%(255))	<i>Set the output percentage value</i>
296	-Brightness toggled	-(NO) -YES	<i>Enable/disable the toggle function for percentage control</i>
297	-Toggled brightness is	(0%(0)..100%(255))	<i>Set another output percentage value, toggle between two of them to send out</i>
298	-Threshold value type	-(1byte threshold) -2bytes threshold	<i>Set the threshold control type</i>
299	-Threshold (0..255) value	0..(255)	<i>Set the threshold value</i>
300	-Threshold(065535) value	0..(1000)..65535	<i>Set the threshold value</i>
301	-Threshold toggled	-(NO) -YES	<i>Enable/disable the toggle function for threshold control</i>
302	-Toggled threshold (0..255) is	0..(255)	<i>Set another output threshold</i>

			<i>value, toggle between two of them to send out</i>
303	-String (14bytes) value	(Hello world!)	<i>Set the output string content</i>
304	Object type 1-10 (long operation)	- (Invalid) - Switch controller - Shutter controller - Scene controller - Sequence controller - Percentage controller - Threshold controller - String (14bytes) controller	<i>it can send several control telegrams simultaneously when long press. Set the control objects' type here</i>
305	-Switch value	-Toggle -(ON) -OFF	<b>Toggle:</b> <i>It will invert the last time's value then send it out. ON: The value it will send is 1. OFF: The value it will send is 0.</i>
306	-Shutter value	-Toggle -(UP) -DOWN	<b>Toggle:</b> <i>it will send move up/down telegram UP: it will send move up telegram Down: it will send move down telegram</i>
307	-Scene value	-(Scene NO.01)..Scene NO.64	<i>Set the output scene number</i>
308	-Scene toggled	-(NO) -YES	<i>Enable/disable the toggle function for scene control</i>
309	-Toggled scene NO. is	-Scene NO.01..(Scene NO.02)..Scene NO.64	<i>Set another output scene number, toggle between two of them to send out</i>
310	-Sequence value	-Toggle -(Start) -Stop	<b>Toggle:</b> <i>It will invert the last time's value then send it out Start with "1": The value it will send is 1 to start the sequence. Stop with "0": The value it will send is 0 to stop the sequence.</i>
311	-Percentage value	0%(0)..(100%(255))	<i>Set the output percentage value</i>
312	-Brightness toggled	-(NO) -YES	<i>Enable/disable the toggle function for percentage control</i>
313	-Toggled brightness is	(0%(0))..100%(255)	<i>Set another output percentage value, toggle between two of them to send out</i>
314	-Threshold value type	-(1byte threshold) -2bytes threshold	<i>Set the threshold control type</i>
315	-Threshold (0..255) value	0..(255)	<i>Set the threshold value</i>
316	-Threshold(065535) value	0..(1000)..65535	<i>Set the threshold value</i>
317	-Threshold toggled	-(NO) -YES	<i>Enable/disable the toggle function for threshold control</i>
318	-Toggled threshold (0..255) is	0..(255)	<i>Set another output threshold value, toggle between two of them to send out</i>
319	-String (14bytes) value	(Hello world!)	<i>Set the output string content</i>

2.1.2\_Channel A-D, Input A-D detection “Temperature sensor”

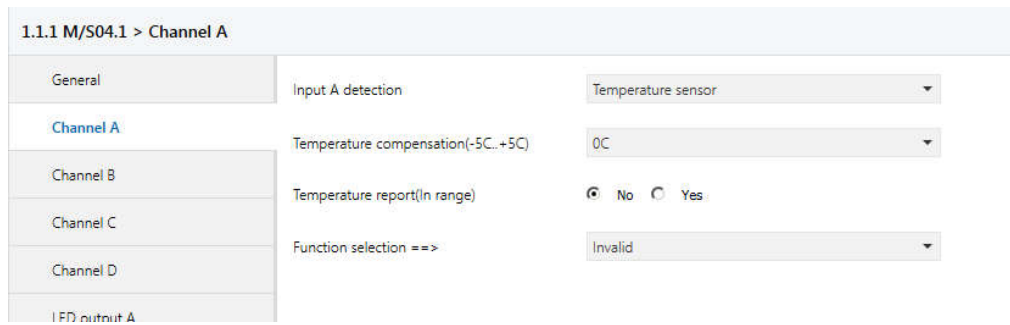

No.	ETS-Parameter	Range (default)	Description
320	Temperature compensation (-5C..+5C)	-5C..(0C)..+5C	Used to adjust temperature to the correct value
321	Temperature report (in range)	-(NO) -YES	Enable/disable the temperature report function when it's in the effective range
322	Function selection	-(Invalid) -Switch controller -Alarm controller -Shutter controller -Scene controller -Sequence controller -Percentage controller -Threshold controller -String (14bytes) controller -Forced position controller -Combination controller	Select the output type for temperature control

2.1.2.1\_Switch controller



1.1.1 M/S04.1 > Channel A

General	Input A detection	Temperature sensor
Channel A	Temperature compensation(-5C..+5C)	0C
Channel B	Temperature report(In range)	<input checked="" type="radio"/> No <input type="radio"/> Yes
Channel C	Function selection ==>	Switch controller
Channel D	-> Temperature >= Threshold1(-30C..+50C)	-5
LED output A	-> Temperature <= Threshold2(-30C..+50C)	30
LED output B	--Change temperature thresholds via bus	<input checked="" type="radio"/> No <input type="radio"/> Yes
LED output C	Temperature control mode	<input checked="" type="radio"/> Temperature range control <input type="radio"/> Temperature point control
LED output D	-> Switch operation(In range)	ON
	-> Switch operation(Out range)	Toggle
	Temperature is detected of minimum time interval:base	1sec

No.	ETS-Parameter	Range (default)	Description
323	Temperature >= Threshold1(-30C..+50C)	-30..(20)..50	Set the threshold 1 value
324	Temperature <= Threshold2(-30C..+50C)	-30..(30)..50	Set the threshold 2 value
325	Change temperature thresholds via bus	-(NO) -YES	Enable/disable to change the temperature's threshold value via bus
326	Temperature control mode	-(Temperature range control) -Temperature point control	<b>Temperature range control:</b> When the temperature in the range will send out the control telegram <b>Temperature point control:</b> When the temperature on the threshold value will send out the control telegram
327	Switch operation (In range)	-Invalid -(ON) -OFF -Toggle	Set the control type for switch when temperature in range <b>Invalid:</b> the switch operation is invalid <b>ON:</b> The value it will send is 1. <b>OFF:</b> The value it will send is 0. <b>Toggle:</b> It will invert the last time's value then send itout.
328	Switch operation (Out range)	-Invalid -ON -(OFF) -Toggle	Set the control type for switch when temperature out of range <b>Invalid:</b> the switch operation is invalid <b>ON:</b> The value it will send is 1. <b>OFF:</b> The value it will send is 0. <b>Toggle:</b> It will invert the last time's value then send itout.

329	Switch operation on threshold1	-Invalid -(ON) -OFF -Toggle	Set the control type for switch when temperature on the threshold1 value <b>Invalid:</b> the switch operation is invalid <b>ON:</b> The value it will send is 1. <b>OFF:</b> The value it will send is 0. <b>Toggle:</b> It will invert the last time's value then send itout.
330	Switch operation on threshold2	-Invalid -ON -(OFF) -Toggle	Set the control type for switch when temperature on the threshold2 value <b>Invalid:</b> the switch operation is invalid <b>ON:</b> The value it will send is 1. <b>OFF:</b> The value it will send is 0. <b>Toggle:</b> It will invert the last time's value then send itout.
331	Temperature is detected of minimum time interval: base	-(1sec) -1min -1hour	These two parameters are used to set the time interval of repeat detection, the time interval = base*factor.
332	-Factor[1..255]- >time=base*factor	1..(5)...255	These two parameters are used to set the time interval of repeat detection, the time interval = base*factor.
333	Forced control('1'-forced control, '0'-temperature control)	-(NO) -YES	<b>NO:</b> Disable forced control function <b>YES:</b> Enable forced control function. When receives telegram 1, temperature control is invalid, will send out the control telegram according to the below 'forced control operation' setting; when receives telegram 0, temperature control is valid, forced control is invalid.
334	-Forced control operation	-Toggle -(ON) -OFF	<b>Toggle:</b> It will invert the last time's value then send itout. <b>ON:</b> The value it will send is 1. <b>OFF:</b> The value it will send is 0.

2.1.2.2\_Alarm controller

1.1.1 M/S04.1 > Channel A

General	Input A detection	Temperature sensor
Channel A	Temperature compensation(-5C..+5C)	0C
Channel B	Temperature report(In range)	<input checked="" type="radio"/> No <input type="radio"/> Yes
Channel C	Function selection ==>	Alarm controller
Channel D	->Temperature>=Threshold1(-30C..+50C)	20
LED output A	->Temperature<=Threshold2(-30C..+50C)	30
LED output B	--Change temperature thresholds via bus	<input checked="" type="radio"/> No <input type="radio"/> Yes
LED output C	Temperature control mode	<input type="radio"/> Temperature range control <input checked="" type="radio"/> Temperature point control
LED output D	->Alarm operation on threshold1	Alarm
	->Alarm operation on threshold2	Toggle
	Temperature is detected of minimum time interval:base	1sec

No.	ETS-Parameter	Range (default)	Description
335	Temperature>=Threshold1(-30C..+50C)	-30..(20)..50	Set the threshold 1 value
336	Temperature<=Threshold2(-30C..+50C)	-30..(30)..50	Set the threshold 2 value
337	Change temperature thresholds via bus	-(NO) -YES	Enable/disable to change the temperature's threshold value via bus
338	Temperature control mode	-(Temperature range control) -Temperature point control	<b>Temperature range control:</b> When the temperature in the range will send out the control telegram <b>Temperature point control:</b> When the temperature on the threshold value will send out the control telegram
339	Alarm operation (In range)	-Invalid -(Alarm) -No alarm -Toggle	Set the control type for alarm when temperature in range <b>Invalid:</b> the alarm operation is invalid <b>Alarm:</b> The value it will send is 1. <b>No alarm:</b> The value it will send is 0. <b>Toggle:</b> It will invert the last time's value then send it out.
340	Alarm operation (Out range)	-Invalid -Alarm -(No alarm) -Toggle	Set the control type for alarm when temperature out of range <b>Invalid:</b> the alarm operation is invalid <b>Alarm:</b> The value it will send is 1.

			<p><b>No alarm:</b>The value it will send is 0.</p> <p><b>Toggle:</b> It will invert the last time's value then send itout</p>
341	Alarm operation on threshold1	<p>-Invalid</p> <p>-(Alarm)</p> <p>-No alarm</p> <p>-Toggle</p>	<p>Set the control type for alarm when temperature on the threshold1 value</p> <p><b>Invalid:</b> the alarm operation is invalid</p> <p><b>Alarm:</b> The value it will send is 1.</p> <p><b>No alarm:</b>The value it will send is 0.</p> <p><b>Toggle:</b> It will invert the last time's value then send itout</p>
342	Alarm operation on threshold2	<p>-Invalid</p> <p>-Alarm</p> <p>-(No alarm)</p> <p>-Toggle</p>	<p>Set the control type for alarm when temperature on the threshold2 value</p> <p><b>Invalid:</b> the alarm operation is invalid</p> <p><b>Alarm:</b> The value it will send is 1.</p> <p><b>No alarm:</b>The value it will send is 0.</p> <p><b>Toggle:</b> It will invert the last time's value then send itout</p>
343	Temperature is detected of minimum time interval: base	<p>-(1sec)</p> <p>-1min</p> <p>-1hour</p>	<p>These two parameters are used to set the time interval of repeat detection, the time interval = base*factor.</p>
344	Factor[1..255]- >time=base*factor	1..(5)...255	<p>These two parameters are used to set the time interval of repeat detection, the time interval = base*factor.</p>
345	Forced control('1'-forced control, '0'-temperature control)	<p>-(NO)</p> <p>-YES</p>	<p><b>NO:</b> Disable forced control function</p> <p><b>YES:</b> Enable forced control function. When receives telegram 1, temperature control is invalid, will send out the control telegram according to the below 'forced control operation' setting; when receives telegram 0, temperature control is valid, forced control is invalid.</p>
346	-Forced control operation	<p>-Toggle</p> <p>-(Alarm)</p> <p>-No alarm</p>	<p><b>Toggle:</b> It will invert the last time's value then send itout</p> <p><b>Alarm:</b> The value it will send is 1.</p> <p><b>No alarm:</b>The value it will send is 0.</p>

2.1.2.3\_Shutter controller

1.1.1 M/S04.1 > Channel A

General	Input A detection	Temperature sensor
Channel A	Temperature compensation(-5C..+5C)	0C
Channel B	Temperature report(In range)	<input checked="" type="radio"/> No <input type="radio"/> Yes
Channel C	Function selection ==>	Shutter controller
Channel D	->Temperature>=Threshold1(-30C..+50C)	20
LED output A	->Temperature<=Threshold2(-30C..+50C)	30
LED output B	--Change temperature thresholds via bus	<input checked="" type="radio"/> No <input type="radio"/> Yes
LED output C	Temperature control mode	<input checked="" type="radio"/> Temperature range control <input type="radio"/> Temperature point control
LED output D	->Shutter operation(In range)	Toggle
	->Shutter operation(Out range)	DOWM
	Temperature is detected of minimum time interval;base	1min

No.	ETS-Parameter	Range (default)	Description
347	Temperature>=Threshold1(-30C..+50C)	-30..(20)..50	Set the threshold 1 value
348	Temperature<=Threshold2(-30C..+50C)	-30..(30)..50	Set the threshold 2 value
349	Change temperature thresholds via bus	-(NO) -YES	Enable/disable to change the temperature's threshold value via bus
350	Temperature control mode	-(Temperature range control) -Temperature point control	<b>Temperature range control:</b> When the temperature in the range will send out the control telegram <b>Temperature point control:</b> When the temperature on the threshold value will send out the control telegram
351	Shutter operation (In range)	-Invalid -(UP) -DOWN -Toggle	Set the control type for shutter when temperature in range <b>Invalid:</b> the shutter operation is invalid <b>UP:</b> it will send the up telegram. <b>DOWN:</b> it will send the down telegram. <b>Toggle:</b> It will invert the last time's value then send itout.
352	Shutter operation (Out range)	-Invalid -UP -(DOWN) -Toggle	Set the control type for shutter when temperature out of range <b>Invalid:</b> the shutter operation is invalid <b>UP:</b> it will send the up

			<p>telegram.  <b>DOWN:</b> it will send the down telegram.  <b>Toggle:</b> It will invert the last time's value then send itout.</p>
353	Shutter operation on threshold1	-Invalid -(UP) -DOWN -Toggle	<p>Set the control type for shutter when temperature on the threshold1 value  <b>Invalid:</b> the shutter operation is invalid  <b>UP:</b> it will send the up telegram.  <b>DOWN:</b> it will send the down telegram.  <b>Toggle:</b> It will invert the last time's value then send itout.</p>
354	Shutter operation on threshold2	-Invalid -UP -(DOWN) -Toggle	<p>Set the control type for shutter when temperature on the threshold2 value  <b>Invalid:</b> the shutter operation is invalid  <b>UP:</b> it will send the up telegram.  <b>DOWN:</b> it will send the down telegram.  <b>Toggle:</b> It will invert the last time's value then send itout.</p>
355	Temperature is detected of minimum time interval: base	-(1sec) -1min -1hour	<p>These two parameters are used to set the time interval of repeat detection, the time interval = base*factor.</p>
356	Factor[1..255]- >time=base*factor	1..(5)...255	<p>These two parameters are used to set the time interval of repeat detection, the time interval = base*factor.</p>
357	Forced control('1'-forced control, '0'-temperature control)	-(NO) -YES	<p><b>NO:</b> Disable forced control function  <b>YES:</b> Enable forced control function. When receives telegram 1, temperature control is invalid, will send out the control telegram according to the below 'forced control operation' setting; when receives telegram 0, temperature control is valid, forced control is invalid.</p>
358	-Forced control operation	-Toggle -(UP) -DOWN	<p><b>Toggle:</b> It will invert the last time's value then send itout.  <b>UP:</b> it will send the up telegram.  <b>DOWN:</b> it will send the down telegram.</p>

2.1.2.4\_Scene controller

1.1.1 M/S04.1 > Channel A

<p>General</p> <hr/> <p>Channel A</p> <hr/> <p>Channel B</p> <hr/> <p>Channel C</p> <hr/> <p>Channel D</p> <hr/> <p>LED output A</p> <hr/> <p>LED output B</p> <hr/> <p>LED output C</p> <hr/> <p>LED output D</p>	<p>Input A detection <span style="float: right;">Temperature sensor ▾</span></p> <p>Temperature compensation(-5C..+5C) <span style="float: right;">0C ▾</span></p> <p>Temperature report(In range) <span style="float: right;"><input checked="" type="radio"/> No <input type="radio"/> Yes</span></p> <p>Function selection ==&gt; <span style="float: right;">Scene controller ▾</span></p> <p>-&gt; Temperature &gt;= Threshold1(-30C..+50C) <span style="float: right;">20 ▾</span></p> <p>-&gt; Temperature &lt;= Threshold2(-30C..+50C) <span style="float: right;">30 ▾</span></p> <p>--Change temperature thresholds via bus <span style="float: right;"><input checked="" type="radio"/> No <input type="radio"/> Yes</span></p> <p>Temperature control mode <span style="float: right;"><input type="radio"/> Temperature range control <input checked="" type="radio"/> Temperature point control</span></p> <p>-&gt; Call scene operation on threshold1 <span style="float: right;">Scene NO.01 ▾</span></p> <p>-&gt; Call scene operation on threshold2 <span style="float: right;">Scene NO.02 ▾</span></p> <p>Temperature is detected of minimum time interval:base <span style="float: right;">1sec ▾</span></p>
--	---

No.	ETS-Parameter	Range (default)	Description
359	Temperature>=Threshold1(-30C..+50C)	-30..(20)..50	Set the threshold 1 value
360	Temperature<=Threshold2(-30C..+50C)	-30..(30)..50	Set the threshold 2 value
361	Change temperature thresholds via bus	-(NO) -YES	Enable/disable to change the temperature's threshold value via bus
362	Temperature control mode	-(Temperature range control) -Temperature point control	<b>Temperature range control:</b> When the temperature in the range will send out the control telegram <b>Temperature point control:</b> When the temperature on the threshold value will send out the control telegram
363	Call scene operation (In range)	-Invalid -(Scene NO.01)..Scene NO.64	Set the output scene number when temperature in range
364	Call scene operation (Out range)	-Invalid -Scene NO.01..(Scene NO.02)..Scene NO.64	Set the output scene number when temperature out of range
365	Call scene operation on threshold1	-Invalid -Scene NO.01..(Scene NO.02)..Scene NO.64	Set the output scene number when temperature on the threshold1 value
366	Call scene operation on threshold2	-Invalid -Scene NO.01..(Scene NO.02)..Scene NO.64	Set the output scene number when temperature on the threshold2 value
367	Temperature is detected of minimum time interval: base	-(1sec) -1min -1hour	These two parameters are used to set the time interval of repeat detection, the time

			<i>interval = base*factor.</i>
368	Factor[1..255]- >time=base*factor	1..(5)...255	<i>These two parameters are used to set the time interval of repeat detection, the time interval = base*factor.</i>
369	Forced control('1'-forced control, '0'-temperature control)	-(NO) -YES	<i>NO: Disable forced control function YES: Enable forced control function. When receives telegram 1, temperature control is invalid, will send out the control telegram according to the below 'forced control operation' setting; when receives telegram 0, temperature control is valid, forced control is invalid.</i>
370	-Forced control operation	Scene NO.01..(Scene NO.03)..Scene NO.64	<i>Set the output scene number for forced control</i>

2.1.2.5\_Sequence controller

No.	ETS-Parameter	Range (default)	Description
371	Temperature>=Threshold1(-30C..+50C)	-30..(20)..50	<i>Set the threshold 1 value</i>
372	Temperature<=Threshold2(-30C..+50C)	-30..(30)..50	<i>Set the threshold 2 value</i>
373	Change temperature thresholds via bus	-(NO) -YES	<i>Enable/disable to change the temperature's threshold</i>



			<i>value via bus</i>
374	Temperature control mode	- (Temperature range control) - Temperature point control	<b>Temperature range control:</b> <i>When the temperature in the range will send out the control telegram</i> <b>Temperature point control:</b> <i>When the temperature on the threshold value will send out the control telegram</i>
375	Sequence operation (In range)	- Invalid - (Start) - Stop - Toggle	<i>Set the control type of sequence when temperature in range</i> <b>Start:</b> <i>The value it will send is 1 to start the sequence.</i> <b>Stop:</b> <i>The value it will send is 0 to stop the sequence.</i> <b>Toggle:</b> <i>It will invert the last time's value then send it out when short press</i>
376	Sequence operation (Out range)	- Invalid - Start - (Stop) - Toggle	<i>Set the control type of sequence when temperature out of range</i> <b>Start:</b> <i>The value it will send is 1 to start the sequence.</i> <b>Stop:</b> <i>The value it will send is 0 to stop the sequence.</i> <b>Toggle:</b> <i>It will invert the last time's value then send it out when short press</i>
377	Sequence operation on threshold1	- Invalid - (Start) - Stop - Toggle	<i>Set the control type of sequence when temperature on the threshold1 value</i> <b>Start:</b> <i>The value it will send is 1 to start the sequence.</i> <b>Stop:</b> <i>The value it will send is 0 to stop the sequence.</i> <b>Toggle:</b> <i>It will invert the last time's value then send it out when short press</i>
378	Sequence operation on threshold2	- Invalid - Start - (Stop) - Toggle	<i>Set the control type of sequence when temperature on the threshold2 value</i> <b>Start:</b> <i>The value it will send is 1 to start the sequence.</i> <b>Stop:</b> <i>The value it will send is 0 to stop the sequence.</i> <b>Toggle:</b> <i>It will invert the last time's value then send it out when short press</i>
379	Temperature is detected of minimum time interval: base	- (1sec) - 1min - 1hour	<i>These two parameters are used to set the time interval of repeat detection, the time</i>

			<i>interval = base*factor.</i>
380	Factor[1..255]- >time=base*factor	1..(5)...255	<i>These two parameters are used to set the time interval of repeat detection, the time interval = base*factor.</i>
381	Forced control('1'-forced control, '0'-temperature control)	-(NO) -YES	<i>NO: Disable forced control function YES: Enable forced control function. When receives telegram 1, temperature control is invalid, will send out the control telegram according to the below 'forced control operation' setting; when receives telegram 0, temperature control is valid, forced control is invalid.</i>
382	-Forced control operation	-Toggle -(Start) -Stop	<b>Toggle:</b> It will invert the last time's value then send it out when short press <b>Start:</b> The value it will send is 1 to start the sequence. <b>Stop:</b> The value it will send is 0 to stop the sequence.

2.1.2.6\_Percentage controller

1.1.1 M/S04.1 > Channel A

General	Input A detection	Temperature sensor
Channel A	Temperature compensation(-5C..+5C)	0C
Channel B	Temperature report(In range)	<input checked="" type="radio"/> No <input type="radio"/> Yes
Channel C	Function selection ==>	Percentage controller
Channel D	-> Temperature >= Threshold1(-30C..+50C)	20
LED output A	-> Temperature <= Threshold2(-30C..+50C)	30
LED output B	--Change temperature thresholds via bus	<input checked="" type="radio"/> No <input type="radio"/> Yes
LED output C	Temperature control mode	<input type="radio"/> Temperature range control <input checked="" type="radio"/> Temperature point control
LED output D	-> Percentage operation on threshold1	100%(255)
	-> Percentage operation on threshold2	0%(0)
	Temperature is detected of minimum time interval:base	1sec

No.	ETS-Parameter	Range (default)	Description
-----	---------------	-----------------	-------------

383	Temperature>=Threshold1(-30C..+50C)	-30..(20)..50	Set the threshold 1 value
384	Temperature<=Threshold2(-30C..+50C)	-30..(30)..50	Set the threshold 2 value
385	Change temperature thresholds via bus	-(NO) -YES	Enable/disable to change the temperature's threshold value via bus
386	Temperature control mode	-(Temperature range control) -Temperature point control	<b>Temperature range control:</b> When the temperature in the range will send out the control telegram <b>Temperature point control:</b> When the temperature on the threshold value will send out the control telegram
387	Percentage operation (In range)	-Invalid -0%(0)..(100%(255))	Set the output percentage value when temperature in range
388	Percentage operation (Out range)	-Invalid -(0%(0)..100%(255))	Set the output percentage value when temperature out of range
389	Percentage operation on threshold1	-Invalid -0%(0)..(100%(255))	Set the output percentage value when temperature on the threshold1 value
390	Percentage operation on threshold2	-Invalid -(0%(0)..100%(255))	Set the output percentage value when temperature on the threshold2 value
391	Temperature is detected of minimum time interval: base	-(1sec) -1min -1hour	These two parameters are used to set the time interval of repeat detection, the time interval = base*factor.
392	Factor[1..255]->time=base*factor	1..(5)...255	These two parameters are used to set the time interval of repeat detection, the time interval = base*factor.
393	Forced control('1'-forced control, '0'-temperature control)	-(NO) -YES	NO: Disable forced control function YES: Enable forced control function. When receives telegram 1, temperature control is invalid, will send out the control telegram according to the below 'forced control operation' setting; when receives telegram 0, temperature control is valid, forced control is invalid.
394	-Forced control operation	0%(0)..(100%(255))	Set the output percentage value for forced control

2.1.2.7\_Threshold controller

1.1.1 M/S04.1 > Channel A

General	Input A detection	Temperature sensor
Channel A	Temperature compensation(-5C..+5C)	0C
Channel B	Temperature report(In range)	<input checked="" type="radio"/> No <input type="radio"/> Yes
Channel C	Function selection ==>	Threshold controller
Channel D	-> Temperature >= Threshold1(-30C..+50C)	20
LED output A	-> Temperature <= Threshold2(-30C..+50C)	30
LED output B	--Change temperature thresholds via bus	<input checked="" type="radio"/> No <input type="radio"/> Yes
LED output C	Temperature control mode	<input type="radio"/> Temperature range control <input checked="" type="radio"/> Temperature point control
LED output D	Threshold value type	<input type="radio"/> 1byte threshold <input checked="" type="radio"/> 2bytes threshold
	->Threshold operation(TEMP threshold1)	<input type="radio"/> No <input checked="" type="radio"/> Yes
	-Threshold value(0..65535)	0

No.	ETS-Parameter	Range (default)	Description
395	Temperature >= Threshold1(-30C..+50C)	-30..(20)..50	Set the threshold 1 value
396	Temperature <= Threshold2(-30C..+50C)	-30..(30)..50	Set the threshold 2 value
397	Change temperature thresholds via bus	-(NO) -YES	Enable/disable to change the temperature's threshold value via bus
398	Temperature control mode	-(Temperature range control) -Temperature point control	<b>Temperature range control:</b> When the temperature in the range will send out the control telegram <b>Temperature point control:</b> When the temperature on the threshold value will send out the control telegram
399	Threshold value type	-(1byte threshold) -2bytes threshold	Set the threshold control type
400	Threshold operation (In range)	-NO -(YES)	Enable/disable the threshold control function when the temperature in range
401	Threshold value (0..255)	(0)..255	Set the output threshold value
402	Threshold value (0..65535)	(0)..65535	Set the output threshold value
403	Threshold value (Out range)	-NO -(YES)	Enable/disable the threshold control function when the temperature out of range
404	Threshold value (0..255)	(0)..255	Set the output threshold value
405	Threshold value (0..65535)	(0)..65535	Set the output threshold

			<i>value</i>
406	Threshold operation(TEMP threshold1)	-NO -(YES)	<i>Enable/disable the threshold control function when temperature on threshold 1 value</i>
407	Threshold value (0..255)	(0)..255	<i>Set the output threshold value</i>
408	Threshold value (0..65535)	(0)..65535	<i>Set the output threshold value</i>
409	Threshold operation(TEMP threshold2)	-NO -(YES)	<i>Enable/disable the threshold control function when temperature on threshold 2 value</i>
410	Threshold value (0..255)	(0)..255	<i>Set the output threshold value</i>
411	Threshold value (0..65535)	(0)..65535	<i>Set the output threshold value</i>
412	Temperature is detected of minimum time interval: base	-(1sec) -1min -1hour	<i>These two parameters are used to set the time interval of repeat detection, the time interval = base*factor.</i>
413	Factor[1..255]- >time=base*factor	1..(5)...255	<i>These two parameters are used to set the time interval of repeat detection, the time interval = base*factor.</i>
414	Forced control('1'-forced control, '0'-temperature control)	-(NO) -YES	<i>NO: Disable forced control function YES: Enable forced control function. When receives telegram 1, temperature control is invalid, will send out the control telegram according to the below 'forced threshold value' setting; when receives telegram 0, temperature control is valid, forced control is invalid.</i>
415	-Forced threshold value (0..255)	(0)..255	<i>Set the output threshold value</i>
416	-Forced threshold value (0..65535)	(0)..65535	<i>Set the output threshold value</i>

2.1.2.8\_String(14bytes) controller

1.1.1 M/S04.1 > Channel A

General	Temperature compensation(-5C..+5C)	0C
Channel A	Temperature report(In range)	<input checked="" type="radio"/> No <input type="radio"/> Yes
Channel B	Function selection ==>	String(14bytes) controller
Channel C	->Temperature>=Threshold1(-30C..+50C)	20
Channel D	->Temperature<=Threshold2(-30C..+50C)	30
LED output A	--Change temperature thresholds via bus	<input checked="" type="radio"/> No <input type="radio"/> Yes
LED output B	Temperature control mode	<input type="radio"/> Temperature range control <input checked="" type="radio"/> Temperature point control
LED output C	->String(14bytes) operation on threshold1	Hello world!
LED output D	->String(14bytes) operation on threshold2	Hello world!
	Temperature is detected of minimum time interval:base	1sec
	-Factor[1..255]->time=base*factor	5

No.	ETS-Parameter	Range (default)	Description
417	Temperature>=Threshold1(-30C..+50C)	-30..(20)..50	Set the threshold 1 value
418	Temperature<=Threshold2(-30C..+50C)	-30..(30)..50	Set the threshold 2 value
419	Change temperature thresholds via bus	-(NO) -YES	Enable/disable to change the temperature's threshold value via bus
420	Temperature control mode	-(Temperature range control) -Temperature point control	<b>Temperature range control:</b> When the temperature in the range will send out the control telegram <b>Temperature point control:</b> When the temperature on the threshold value will send out the control telegram
421	String (14bytes) operation (In range)	(Hello world!)	Set the output string content when temperature in range
422	String (14bytes) operation (Out range)	(Hello world!)	Set the output string content when temperature out of range
423	String (14bytes) operation on threshold1	(Hello world!)	Set the output string content when temperature on the threshold1 value
424	String (14bytes) operation on threshold2	(Hello world!)	Set the output string content when temperature on the threshold2 value
425	Temperature is detected of minimum time interval: base	-(1sec) -1min -1hour	These two parameters are used to set the time interval of repeat detection, the time

			<i>interval = base*factor.</i>
426	Factor[1..255]- >time=base*factor	1..(5)...255	<i>These two parameters are used to set the time interval of repeat detection, the time interval = base*factor.</i>
427	Forced control('1'-forced control, '0'-temperature control)	-(NO) -YES	<i>NO: Disable forced control function YES: Enable forced control function. When receives telegram 1, temperature control is invalid, will send out the control telegram according to the below 'forced control operation' setting; when receives telegram 0, temperature control is valid, forced control is invalid.</i>
428	-Forced control operation	(Hello world!)	<i>Set the output string value for forced control</i>

2.1.2.9\_Forced position controller

1.1.1 M/S04.1 > Channel A

- General: Temperature compensation(-5C..+5C) 0C
- Channel A:
  - Temperature report(In range)  No  Yes
  - Function selection ==> Forced position controller
  - >Temperature>=Threshold1(-30C..+50C) 20
  - >Temperature<=Threshold2(-30C..+50C) 30
  - Change temperature thresholds via bus  No  Yes
  - Temperature control mode  Temperature range control  Temperature point control
  - >Forced operation(In range/THR1) 2bytes value(-32768..32767)
  - Transmitted value(-32768..32767) 0
  - >Forced operation(Out range/THR2) 1byte value(0..255)
  - Transmitted value(0..255) 0

No.	ETS-Parameter	Range (default)	Description
429	Temperature>=Threshold1(-30C..+50C)	-30..(20)..50	<i>Set the threshold 1 value</i>
430	Temperature<=Threshold2(-30C..+50C)	-30..(30)..50	<i>Set the threshold 2 value</i>
431	Change temperature thresholds via bus	-(NO) -YES	<i>Enable/disable to change the temperature's threshold</i>

			<i>value via bus</i>
432	Temperature control mode	- (Temperature range control) - Temperature point control	<b>Temperature range control:</b> <i>When the temperature in the range will send out the control telegram</i> <b>Temperature point control:</b> <i>When the temperature on the threshold value will send out the control telegram</i>
433	Forced operation (In range/THR1)	- Invalid - (2bits value) - 1byte value(0..255) - 2bytes value (-32768..32767) - 2bytes value(0..65535) - 2bytes value (Float) - 4bytes value (02147483647)	<i>Set the forced control type when temperature in range or on threshold 1</i>
434	- Transmitted value(ON/OFF)	- (ON->control) - OFF-control - No control	<i>Set the control type of 2 bit</i>
435	- Transmitted value(0..255)	(0)..255	<i>Set the transmitted value of 1 byte</i>
436	- Transmitted value(-32768..32767)	-32768..(0)..32767	<i>Set the transmitted value of 2 byte</i>
437	- Transmitted value(0..65535)	(0)..65535	<i>Set the transmitted value of 2 byte</i>
438	- Transmitted value	-100..(0)..100	<i>Set the transmitted value of 2 byte</i>
439	- Transmitted value(0..2147483647)	(0)..2147483647)	<i>Set the transmitted value of 4 byte</i>
440	Forced operation (Out range/THR2)	- Invalid - (2bits value) - 1byte value(0..255) - 2bytes value (-32768..32767) - 2bytes value(0..65535) - 2bytes value (Float) - 4bytes value (0..2147483647)	<i>Set the forced control type when temperature out of range or on threshold 2</i>
441	- Transmitted value(ON/OFF)	- ON->control - (OFF-control) - No control	<i>Set the control type of 2 bit</i>
442	- Transmitted value(0..255)	(0)..255	<i>Set the transmitted value of 1 byte</i>
443	- Transmitted value(-32768..32767)	-32768..(0)..32767	<i>Set the transmitted value of 2 byte</i>
444	- Transmitted value(0..65535)	(0)..65535	<i>Set the transmitted value of 2 byte</i>
445	- Transmitted value	-100..(0)..100	<i>Set the transmitted value of 2 byte</i>
446	- Transmitted value(0..2147483647)	(0)..2147483647)	<i>Set the transmitted value of 4 byte</i>
447	Temperature is detected of minimum time interval: base	-(1sec) -1min -1hour	<i>These two parameters are used to set the time interval of repeat operation, the time interval = base*factor.</i>
448	Factor[1..255]-	1..(5)...255	<i>These two parameters are</i>



	>time=base*factor		used to set the time interval of repeat operation, the time interval = base*factor.
--	-------------------	--	---

2.1.2.10\_ Combination controller

The screenshot shows the configuration page for '1.1.1 M/S04.1 > Channel A'. The left sidebar lists options: General, Channel A (selected), Channel B, Channel C, Channel D, LED output A, LED output B, LED output C, and LED output D. The main area contains the following settings:

- Input A detection: Temperature sensor
- Temperature compensation(-5C..+5C): 0C
- Temperature report(In range):  No  Yes
- Function selection ==>: Combination controller
- > Temperature >= Threshold1(-30C..+50C): 20
- > Temperature <= Threshold2(-30C..+50C): 30
- Change temperature thresholds via bus:  No  Yes
- Temperature control mode:  Temperature range control  Temperature point control
- Temperature is detected of minimum time interval:base: 1sec
- Factor[1..255]->time=base\*factor: 5
- Combination operation: In range->

No.	ETS-Parameter	Range (default)	Description
449	Temperature>=Threshold1(-30C..+50C)	-30..(20)..50	Set the threshold 1 value
450	Temperature<=Threshold2(-30C..+50C)	-30..(30)..50	Set the threshold 2 value
451	Change temperature thresholds via bus	-(NO) -YES	Enable/disable to change the temperature's threshold value via bus
452	Temperature control mode	-(Temperature range control) -Temperature point control	<b>Temperature range control:</b> When the temperature in the range will send out the control telegram <b>Temperature point control:</b> When the temperature on the threshold value will send out the control telegram
453	Temperature is detected of minimum time interval: base	-(1sec) -1min -1hour	These two parameters are used to set the time interval of repeat detection, the time interval = base*factor.
454	Factor[1..255]->time=base*factor	1..(5)...255	These two parameters are used to set the time interval

			<i>of repeat detection, the time interval = base*factor.</i>
455	Object type 1 (in range/temperature threshold1)	- (Invalid) - Switch controller - Alarm controller - Shutter controller - Scene controller - Sequence controller - Percentage controller - Threshold controller - String (14bytes) controller	<i>it can send several control telegrams simultaneously when temperature in range or on threshold 1 value. Set the control objects' type here</i>
456	- Switch value	- (ON) - OFF	<b>ON:</b> The value it will send is 1. <b>OFF:</b> The value it will send is 0.
457	- Alarm value	- No alarm - (Alarm)	<b>No Alarm:</b> The value it will send is 0. <b>Alarm:</b> The value it will send is 1.
458	- Shutter value	- (UP) - DOWN	<b>UP:</b> it will send move up telegram <b>Down:</b> it will send move down telegram
459	- Scene value	- (Scene NO.01)..Scene NO.64	<i>Set the output scene number</i>
460	- Sequence value	- (Start) - Stop	<b>Start :</b> The value it will send is 1 to start the sequence. <b>Stop:</b> The value it will send is 0 to stop the sequence.
461	- Percentage value	0%(0)..(100%(255))	<i>Set the output percentage value</i>
462	- Threshold value type	- (1byte threshold) - 2bytes threshold	<i>Set the threshold control type</i>
463	- Threshold (0..255) value	0..(255)	<i>Set the threshold value</i>
464	- Threshold(065535) value	0..(1000)..65535	<i>Set the threshold value</i>
465	- String (14bytes) value	(Hello world!)	<i>Set the output string content</i>
466	Object type 1-10 (Out range/temperature threshold2)	- (Invalid) - Switch controller - Alarm controller - Shutter controller - Scene controller - Sequence controller - Percentage controller - Threshold controller - String (14bytes) controller	<i>it can send several control telegrams simultaneously when temperature out of range or on threshold 2 value. Set the control objects' type here</i>
467	- Switch value	- ON - (OFF)	<b>ON:</b> The value it will send is 1. <b>OFF:</b> The value it will send is 0.
468	- Alarm value	- (No alarm) - Alarm	<b>No Alarm:</b> The value it will send is 0. <b>Alarm:</b> The value it will send is 1.
469	- Shutter value	- UP - (DOWN)	<b>UP:</b> it will send move up telegram <b>Down:</b> it will send move down telegram
470	- Scene value	- Scene NO.01..(Scene NO.02)..Scene NO.64	<i>Set the output scene number</i>

471	-Sequence value	-Start -(Stop)	<b>Start</b> : The value it will send is 1 to start the sequence. <b>Stop</b> : The value it will send is 0 to stop the sequence.
472	-Percentage value	(0%(0))..100%(255)	Set the output percentage value
473	-Threshold value type	-(1byte threshold) -2bytes threshold	Set the threshold control type
474	-Threshold (0..255) value	(0)..255	Set the threshold value
475	-Threshold(065535) value	(0)..65535	Set the threshold value
476	-String (14bytes) value	(Hello world!)	Set the output string content

2.2\_LED Output A-D

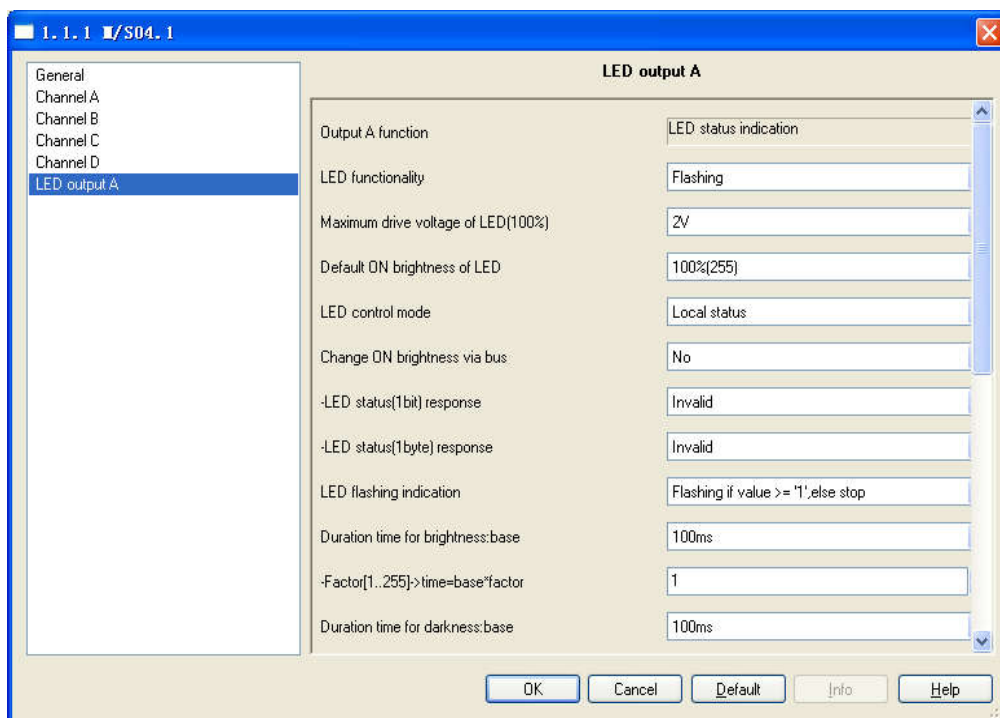

No.	ETS-Parameter	Range (default)	Description
477	LED functionality	-(Switch status ON/OFF) -Flashing	<b>Switch state ON/OFF</b> :the LED shows the on/off states of object <b>Flashing</b> : the LED's state is flashing.
478	Maximum drive voltage of LED(100%)	1V,(2V)..10V	Set the maximum drive voltage of LED. The range is 1V to 10V.
479	Default ON brightness of LED	10%..(100%255)	Set the default brightness of LED when on.
480	LED control mode	-(Local status) -Via bus (1bit-Operation and	Set the control mode of LED. <b>Local status</b> : The LED is controlled by local

		1byte-Brightness)	status. <b>Via bus:</b> the LED is controlled by the telegram via bus.
481	Change ON brightness via bus	(NO), YES	Enable/disable the function that change on brightness via bus. <b>NO:</b> you can't change on brightness via bus. <b>YES:</b> you can change on brightness via bus.
482	LED status (1 bit) response	-(Invalid) -1 bit always response -1 bit only changed	Set the 1 bit response type of LED status. <b>1 bit always response:</b> it will always report its status to the system. <b>1 bit only changed:</b> it will only report its status to the system when status changes.
483	LED status (1 byte) response	-(Invalid) -1 byte always response -1 byte only changed	Set the 1 byte response type of LED status. <b>1 byte always response:</b> it will always report its status to the system. <b>1 byte only changed:</b> it will only report its status to the system when status changes.
484	LED status after bus voltage	(unchanged), ON, OFF	Set to LED state after bus voltage recovery.
<b>2.2.1_Switch status ON/OFF</b>			
485	LED indication	-(ON if value>='1', else OFF) -ON if value is '0', else OFF -Always ON -Always OFF	<b>ON if value&gt;='1', else OFF:</b> if the value>='1', LED state is ON, else LED state is OFF. <b>ON if value is '0', else OFF:</b> if the value is 0, LED state is ON, else LED state is OFF. <b>Always ON:</b> LED state is always on. <b>Always OFF:</b> LED state is always OFF.
486	LED automatically darker after a delay (Valid only LED status is ON)	(NO), YES	Enable/disable the LED automatically darker function when has no operation
487	LED automatically darker brightness	0%,(1%)..100%255	Set the brightness value when darken.
488	LED automatically darker delay time: base	100ms, (1sec), 1min 1hour	These two parameters are used to set the delay time for auto darken, the delay time = base*factor.
489	Factor[1..255]->time=base*factor	1..(5)..255	These two parameters are used to set the delay time for auto darken, the delay time = base*factor.
<b>2.2.2_Flashing</b>			
490	LED flashing indication	-(Flashing if value>='1', else stop) -Flashing if value is '0', else stop -Always flashing	<b>Flashing if value&gt;='1', else OFF:</b> if the value>='1', LED state is flashing; else LED state is static. <b>Flashing if value is '0', else OFF:</b> if the value is 0, LED state is flashing; else LED state is static. <b>Always flashing:</b> LED state is always flashing.
491	Duration time for brightness: base	-10ms -(100ms) -1sec	These two parameters are used to set the fade time to on the LED, the fade time=base*factor.

		-1min -1hour	
492	Factor[1..255]- >time=base*factor	(1)..255	<i>These two parameters are used to set the fade time to on the LED, the fade time=base*factor. The LED will reach the setting on brightness after the fade time.</i>
493	Duration time for darkness: base	-10ms -(100ms) -1sec -1min -1hour	<i>These two parameters are used to set the fade time to off the LED, the fade time=base*factor.</i>
494	Factor[1..255]- >time=base*factor	(1)..255	<i>These two parameters are used to set the fade time to off the LED, the fade time=base*factor. The LED will off after the fade time.</i>
495	Flashing time limit	(NO), YES	<i>These two parameters are used to set the valid time of flashing, after this time, the LED will stop flashing</i>
496	Flashing time limit: base	-(1sec) -1min -1hour	<i>These two parameters are used to set the valid time for LED flashing, the valid time=base*factor.</i>
497	Factor[1..255]- >time=base*factor	1..(5)..255	<i>These two parameters are used to set the valid time for LED flashing, the valid time=base*factor.</i>
	LED status after stop	(unchanged), ON, OFF	<i>Set the LED status after stop flashing</i>

XX

3.0_Logical controller
------------------------

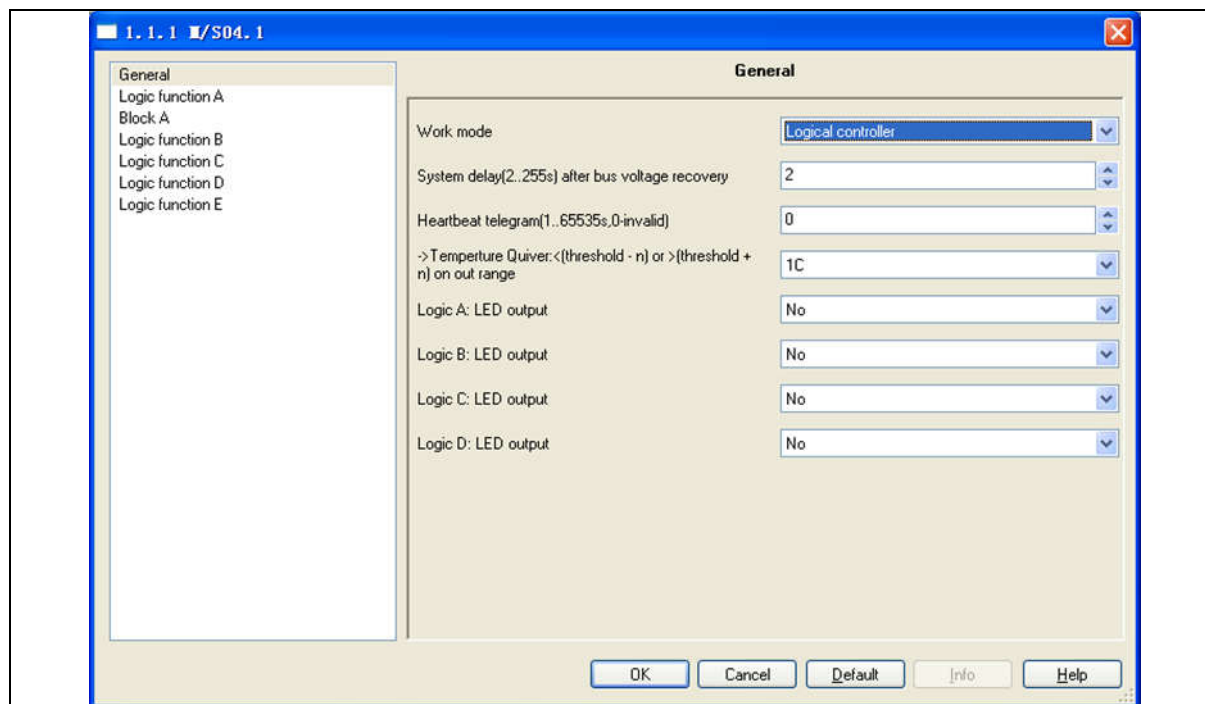

No.	ETS-Parameter	Range (default)	Description
498	Work mode	- (Sensors controller) - <b>Logical controller</b> - Dimming controller	Set the work mode: Logical controller
499	System delay (2-255s) after bus voltage recovery	(2)..255s	Set the delay time for the device to work after power on, the range is 2-255s
500	Heartbeat telegram (1..65535s,0-invalid)	(0)..65535s	If the parameter is set to nonzero, the device will send a telegram data (alternately between 0 and 1) cyclically after time out; if it's set to 0, this function is invalid.
501	Temperature Quiver: <(threshold - n) or >(threshold +n) on out range)	0C, (1C),...10C	The effective range is larger than threshold1 and less than threshold2 The setting range is larger than the (threshold1-n) and less than (threshold2+n). Suppose the temperature is in the effective range, when it changes within the setting range, the status will not change. Suppose the temperature is in the effective range, when it changes out of the setting range, the status will change. Suppose the temperature is not in the effective range, only when the temperature changes into the effective range, the status will change.
502	Logic A: LED output Logic B: LED output Logic C: LED output Logic D: LED output	(NO), YES	<b>NO:</b> LED output is invalid. <b>YES:</b> it will appear a setting page of the "LED output A". That page is used to set the LED state parameter. Channel B,C,D outputs are same as Channel A.

3.1\_Logic A-D Led output

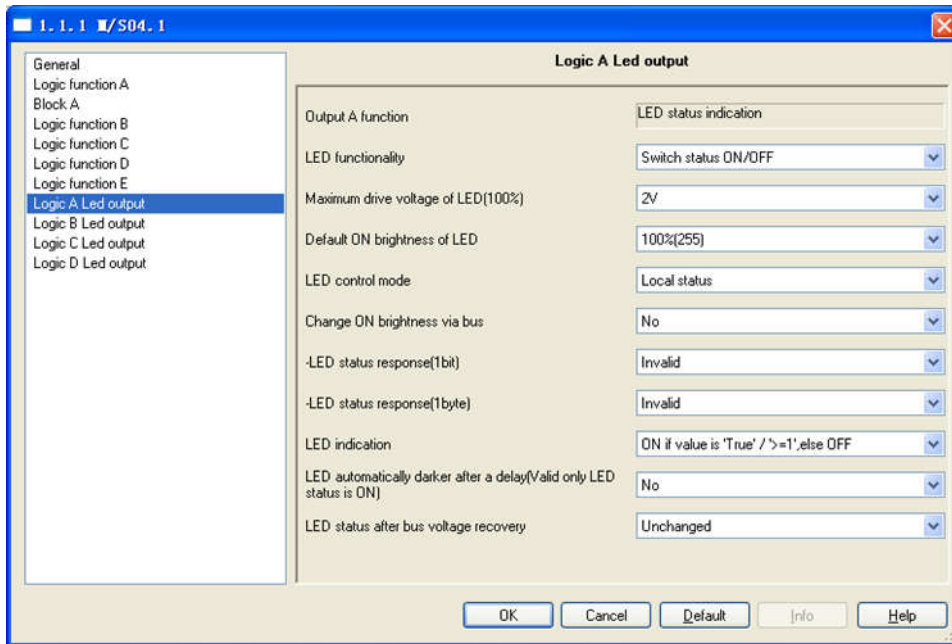

No.	ETS-Parameter	Range (default)	Description
503	LED functionality	-(Switch status ON/OFF) -Flashing	<b>Switch state ON/OFF:</b> the LED shows the on/off states of object <b>Flashing:</b> the LED's state is flashing.
504	Maximum drive voltage of LED(100%)	1V,(2V)..10V	Set the maximum drive voltage of LED. The range is 1V to 10V.
505	Default ON brightness of LED	10%..100%(255)	Set the default brightness of LED when on.
506	LED control mode	-(Local status) -Via bus (1bit-Operation and 1byte-Brightness)	Set the control mode of LED. <b>Local status:</b> The LED is controlled by local status. <b>Via bus:</b> the LED is controlled by the telegram via bus.
507	Change ON brightness via bus	(NO), YES	Enable/disable the function that change on brightness via bus. <b>NO:</b> you can't change on brightness via bus. <b>YES:</b> you can change on brightness via bus.
508	LED status (1 bit) response	-(Invalid) -1 bit always response -1 bit only changed	Set the 1 bit response type of LED status. <b>1 bit always response:</b> it will always report its status to the system. <b>1 bit only changed:</b> it will only report its status to the system when status changes.
509	LED status (1 byte) response	-(Invalid) -1 byte always response -1 byte only changed	Set the 1 byte response type of LED status. <b>1 byte always response:</b> it will always report its status to the system. <b>1 byte only changed:</b> it will only report its status to the system when status changes.
510	LED status after bus voltage recovery	-(unchanged) -ON -OFF	Set to LED state after bus voltage recovery.
<b>3.1.1 Switch status ON/OFF</b>			
511	LED indication	-(ON if value>='1', else OFF) -ON if value is '0', else	<b>ON if value&gt;='1', else OFF:</b> if the value>="1", LED state is ON, else LED state is OFF.

		OFF -Always ON -Always OFF	<b>ON if value is '0', else OFF:</b> if the value is 0, LED state is ON, else LED state is OFF. <b>Always ON:</b> LED state is always on. <b>Always OFF:</b> LED state is always OFF.
512	LED automatically darker after a delay (Valid only LED status is ON)	(NO), YES	Enable/disable the LED automatically darker function when has no operation
513	-LED automatically darker brightness	0%,(1%)..100%255	Set the brightness value when darken.
514	-LED automatically darker delay time: base	100ms, (1sec), 1min 1hour	These two parameters are used to set the delay time for auto darken, the delay time = base*factor.
515	-Factor[1..255]- >time=base*factor	1..(5)..255	These two parameters are used to set the delay time for auto darken, the delay time = base*factor.
<b>3.1.2 Flashing</b>			
516	LED flashing indication	-(Flashing if value>='1', else stop) -Flashing if value is '0', else stop -Always flashing	<b>Flashing if value&gt;='1', else OFF:</b> if the value>='1', LED state is flashing; else LED state is static. <b>Flashing if value is '0', else OFF:</b> if the value is 0, LED state is flashing; else LED state is static. <b>Always flashing:</b> LED state is always flashing.
517	Duration time for brightness: base	-10ms -(100ms) -1sec -1min -1hour	These two parameters are used to set the fade time to on the LED, the fade time=base*factor.
518	Factor[1..255]- >time=base*factor	(1)..255	These two parameters are used to set the fade time to on the LED, the fade time=base*factor. The LED will reach the setting on brightness after the fade time.
519	Duration time for darkness: base	-10ms -(100ms) -1sec -1min -1hour	These two parameters are used to set the fade time to off the LED, the fade time=base*factor.
520	Factor[1..255]- >time=base*factor	(1)..255	These two parameters are used to set the fade time to off the LED, the fade time=base*factor. The LED will off after the fade time.
521	Flashing time limit	(NO), YES	These two parameters are used to set the valid time of flashing, after this time, the LED will stop flashing
522	Flashing time limit: base	-10ms -(100ms) -1sec -1min -1hour	These two parameters are used to set the valid time for LED flashing, the valid time=base*factor.
523	Factor[1..255]- >time=base*factor	1..(5)..255	These two parameters are used to set the valid time for LED flashing, the valid time=base*factor.
524	LED status after stop	-unchanged -ON -(OFF)	Set the LED status after stop flashing



3.2\_Logic function A-D

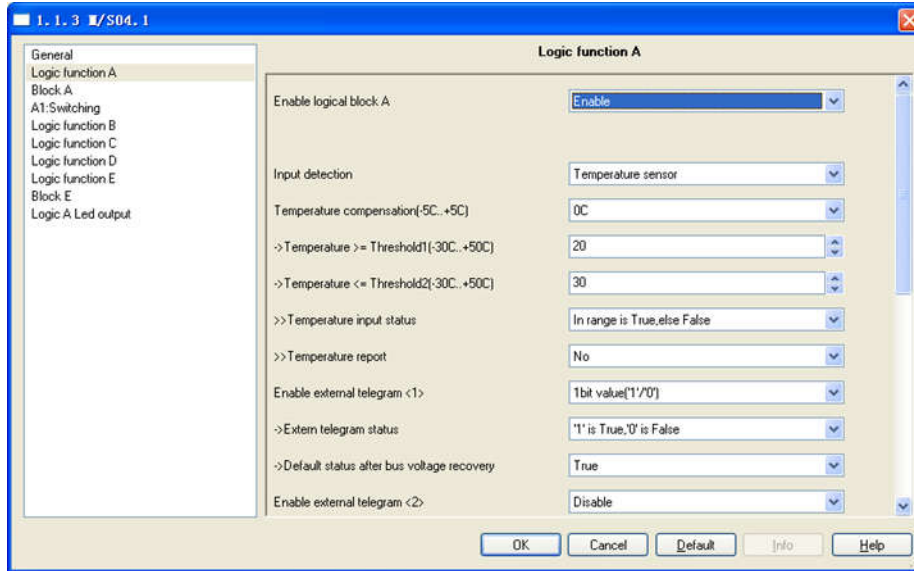

No.	ETS-Parameter	Range (default)	Description
525	Enable logical block A-D	-(Disable) -Enable	<b>Disable:</b> the logical block A is invalid. <b>Enable:</b> Enable logic block A's function.
526	Input detection A-D	-(No detection) -Dry contact sensor -Temperature sensor	<b>Disable:</b> disable the input detection <b>Dry contact sensor:</b> set dry contact sensor as the input detection. <b>Temperature sensor:</b> set the temperature sensor as input detection.

3.2.1\_Dry contact sensor

527	Dry contact type	-(Mechanical switch) -Electronic switch	Function selection
-----	------------------	--	--------------------

3.2.1.1\_Mechanical switch

528	Status when closing the contact	-Invalid -(True) -False -Toggle	Set the logic status when closing the contact <b>Invalid:</b> it's invalid <b>True:</b> set the logic status to be true <b>False:</b> set the logic status to be false <b>Toggle:</b> it will invert the last time's status then send it out
529	Status when opening the contact	-Invalid -True -(False) -Toggle	Set the logic status when opening the contact <b>Invalid:</b> it's invalid <b>True:</b> set the logic status to be true <b>False:</b> set the logic status to be false <b>Toggle:</b> it will invert the last time's status then send it out
530	Dry contact status report	-(No) -Yes	<b>No:</b> will not report contact's status to the bus <b>Yes:</b> will report contact's status to the bus
531	Dry status report mode	-(Report when changed) -Report cyclic	<b>Report when changed:</b> it will report the contact status to the bus only when it's changed

			<b>Report cyclic:</b> it will report the contact status to the bus cyclically
532	Dry status report of minimum time interval: base	(1sec..1hour)	This parameter is used to set the time base of status report when changed.
533	Dry status report cycle: base	(1sec..1hour)	This parameter is used to set the time base of status report cyclically.
534	Factor[1..255]->time=base*factor	(1)..255	This parameter is used to set the time factor, the time interval=base*factor
535	Enable external telegram <1>..<>5>	-(Disable) -1bit value('1'/'0') -1byte threshold (0..255) -2bytes threshold (0..65535) -2bytes float threshold (0..3000) -4bytes threshold (0..2147483647)	Set the external telegram's type here.
536	Extern telegram status	-'1' is True, '0' is False) -'0' is True, '1' is False	'1' is True, '0' is False: when receives 1, the input status is true; when receives 0, the input status is false '0' is True, '1' is False: when receives 0, the input status is true; when receives 1, the input status is false
537	Default status after bus voltage recovery	-(True) -False	Set the default status of external telegram after voltage recovery.
538	1byte threshold(0..255)	0..(100)..255	Set the threshold value of 1 byte
539	Quiver:<(threshold-n) or >(threshold+n) on false	0..(1)..255	Set the quiver value for threshold, when it receives the value <threshold-n or >threshold+n, the input status is false
540	Extern telegram status	-(True if REV value>=Threshold, else False) -True if REV value<=Threshold, else False	<b>True if REV value &gt;= threshold, else False:</b> when external telegram value >= threshold, the input status is true, else is false. <b>True if REV value &lt;= threshold, else False:</b> when external telegram value <= threshold, the input status is true, else is false.
541	Default status after bus voltage recovery	-(True) -False	Set the default status as true or false after voltage recovery.
542	2byte threshold(0..65535)	0..(1000)..65535	Set the threshold value of 2bytes
543	Quiver:<(threshold-n) or >(threshold+n) on false	0..(1)..255	Set the quiver value for threshold, when it receives the value <threshold-n or >threshold+n, the input status is false
544	Extern telegram status	-(True if REV value>=Threshold, else False) -True if REV value<=Threshold, else False	<b>True if REV value &gt;= threshold, else False:</b> when external telegram value >= threshold, the input status is true, else is false. <b>True if REV value &lt;= threshold, else False:</b> when external telegram value <= threshold, the input status is true, else is false.
545	Default status after bus voltage recovery	-(True) -False	Set the default status as true or false after voltage recovery.
546	2bytes float threshold(0..3000)	0..(100)..3000	Set the threshold value of 2bytes float

547	Quiver:<(threshold-n) or >(threshold+n) on false	0..(1)..255	Set the quiver value for threshold, when it receives the value <threshold-n or >threshold+n, the input status is false
548	Extern telegram status	-(True if REV value>=Threshold, else False) -True if REV value<=Threshold, else False	<b>True if REV value &gt;= threshold, else False:</b> when external telegram value >= threshold, the input status is true, else is false. <b>True if REV value &lt;= threshold, else False:</b> when external telegram value <= threshold, the input status is true, else is false.
549	Default status after bus voltage recovery	-(True) -False	Set the default status as true or false after voltage recovery.
550	4bytes threshold (0..2147483647)	0..(1000000)..2147483647	Set the threshold value of 4bytes
551	Quiver:<(threshold-n) or >(threshold+n) on false	0..(1)..255	Set the quiver value for threshold, when it receives the value <threshold-n or >threshold+n, the input status is false
552	Extern telegram status	-(True if REV value>=Threshold, else False) -True if REV value<=Threshold, else False	<b>True if REV value &gt;= threshold, else False:</b> when external telegram value >= threshold, the input status is true, else is false. <b>True if REV value &lt;= threshold, else False:</b> when external telegram value <= threshold, the input status is true, else is false.
553	Default status after bus voltage recovery	-(True) -False	Set the default status as true or false after voltage recovery.
<b>3.2.1.2 Electronic switch</b>			
554	The normally contact status is	-closed -(open)	<b>Close:</b> the contact's normal status is closed. <b>Open:</b> the contact's normal status is open
555	Status when short button operation	-Invalid -(True) -False -Toggle	Set the logic status when short press <b>Invalid:</b> it's invalid <b>True:</b> set the logic status to be true <b>False:</b> set the logic status to be false <b>Toggle:</b> it will invert the last time's status then send it out
556	Status when long button operation	-Invalid -True -(False) -Toggle	Set the logic status when long press <b>Invalid:</b> it's invalid <b>True:</b> set the logic status to be true <b>False:</b> set the logic status to be false <b>Toggle:</b> it will invert the last time's status then send it out
557	Long button time after	0.2s..(1s)..60s	Set time for long-press, define the long press by end-user
558	The status after bus voltage recovery	-False -(True)	Set the logic status after bus voltage recovery.
559	Dry contact status report	-No -(Yes)	<b>No:</b> will not report contact's status to the bus <b>Yes:</b> will report contact's status to the bus
560	Dry status report cycle mode	-Report when changed -(Report cyclic)	<b>Report when changed:</b> it will report the contact status to the bus only when it's changed <b>Report cyclic:</b> it will report the contact status to the bus cyclically

561	Dry status report cycle: base	-(1sec) -1min -1hour	<i>This parameter is used to set the time base of status report cyclically.</i>
562	Dry status report of minimum time interval: base	-(1sec) -1min -1hour	<i>This parameter is used to set the time base of status report when changed.</i>
563	Factor[1..255]- >time=base*factor	(1)..255	<i>This parameter is used to set the time factor, the report time interval = base* factor</i>
564	Enable external telegram <1>..<>5>	-(Disable) -1bit value('1'/'0') -1byte threshold (0..255) -2bytes threshold (0..65535) -2bytes float threshold (0..3000) -4bytes threshold (0..2147483647)	<i>Set the external telegram's type here.</i>
565	Extern telegram status	-'1' is True, '0' is False) -'0' is True, '1' is False	<b>'1' is True, '0' is False:</b> when receives 1, the input status is true; when receives 0, the input status is false <b>'0' is True, '1' is False:</b> when receives 0, the input status is true; when receives 1, the input status is false
566	Default status after bus voltage recovery	-(True) -False	<i>Set the default status of external telegram after voltage recovery.</i>
567	1byte threshold(0..255)	0..(100)..255	<i>Set the threshold value of 1 byte</i>
568	Quiver:<(threshold-n) or >(threshold+n) on false	0..(1)..255	<i>Set the quiver value for threshold, when it receives the value &lt;threshold-n or &gt;threshold+n, the input status is false</i>
569	Extern telegram status	-(True if REV value>=Threshold, else False) -True if REV value<=Threshold, else False	<b>True if REV value &gt;= threshold, else False:</b> when external telegram value >= threshold, the input status is true, else is false. <b>True if REV value &lt;= threshold, else False:</b> when external telegram value <= threshold, the input status is true, else is false.
570	Default status after bus voltage recovery	-(True) -False	<i>Set the default status as true or false after voltage recovery.</i>
571	2byte threshold(0..65535)	0..(1000)..65535	<i>Set the threshold value of 2 bytes</i>
572	Quiver:<(threshold-n) or >(threshold+n) on false	0..(1)..255	<i>Set the quiver value for threshold, when it receives the value &lt;threshold-n or &gt;threshold+n, the input status is false</i>
573	Extern telegram status	-(True if REV value>=Threshold, else False) -True if REV value<=Threshold, else False	<b>True if REV value &gt;= threshold, else False:</b> when external telegram value >= threshold, the input status is true, else is false. <b>True if REV value &lt;= threshold, else False:</b> when external telegram value <= threshold, the input status is true, else is false.
574	Default status after bus voltage recovery	-(True) -False	<i>Set the default status as true or false after voltage recovery.</i>
575	2bytes float	0..(100)..3000	<i>Set the threshold value of 2 bytes float</i>

	threshold(0..3000)		
576	Quiver:<(threshold-n) or >(threshold+n) on false	0..(1)..255	Set the quiver value for threshold, when it receives the value <threshold-n or >threshold+n, the input status is false
577	Extern telegram status	-(True if REV value>=Threshold, else False) -True if REV value<=Threshold, else False	<b>True if REV value &gt;= threshold, else False:</b> when external telegram value >= threshold, the input status is true, else is false. <b>True if REV value &lt;= threshold, else False:</b> when external telegram value <= threshold, the input status is true, else is false.
578	Default status after bus voltage recovery	-(True) -False	Set the default status as true or false after voltage recovery.
579	4bytes threshold (0..2147483647)	0..(1000000).. 2147483647	Set the threshold value of 4 bytes
580	Quiver:<(threshold-n) or >(threshold+n) on false	0..(1)..255	Set the quiver value for threshold, when it receives the value <threshold-n or >threshold+n, the input status is false
581	Extern telegram status	-(True if REV value>=Threshold, else False) -True if REV value<=Threshold, else False	<b>True if REV value &gt;= threshold, else False:</b> when external telegram value >= threshold, the input status is true, else is false. <b>True if REV value &lt;= threshold, else False:</b> when external telegram value <= threshold, the input status is true, else is false.
582	Default status after bus voltage recovery	-(True) -False	Set the default status as true or false after voltage recovery.
<b>3.2.2 Temperature sensor</b>			
583	Temperature compensation (-5C..+5C)	-5C..(0C)..+5C	Use to adjust temperature to the correct value
584	Temperature >= Threshold1(-30C..+50C)	-30..(20)..50	Set the threshold 1 value
585	Temperature <= Threshold2(-30C..+50C)	-30..(30)..50	Set the threshold 2 value
586	Temperature input status	-(In range is True, else False) -Out range is True, else False	<b>In range is True, else False:</b> the input status is true when the temperature in the range; else it's false <b>Out range is True, else False:</b> the input status is true when the temperature out of the range; else it's false
587	Temperature report	-(No) -Yes	<b>No:</b> will not report temperature to the bus <b>Yes:</b> will report temperature to the bus when it's in the effective range
588	Temperature report mode	-(Report when changed) -Report cyclic	<b>Report when changed:</b> it will report the temperature to the bus only when it's changed <b>Report cyclic:</b> it will report the temperature to the bus cyclically
589	Temperature report of minimum time interval: base	-(1sec) -1min -1hour	This parameter is used to set the time base of temperature report when changed.

590	Temperature report cycle :base	-(1sec) -1min -1hour	<i>This parameter is used to set the time base of temperature report cyclically.</i>
591	Factor[1..255]- >time=base*factor	1..255	<i>This parameter is used to set the time factor, the report time interval = base* factor</i>
592	Enable external telegram <1>..<<5>	-(Disable) -1bit value('1'/'0') -1byte threshold (0..255) -2bytes threshold (0..65535) -2bytes float threshold (0..3000) -4bytes threshold (0..2147483647)	<i>Set the external telegram's type here.</i>
593	Extern telegram status	-( '1' is True, '0' is False) - '0' is True, '1' is False	<b>'1' is True, '0' is False:</b> when receives 1, the input status is true; when receives 0, the input status is false <b>'0' is True, '1' is False:</b> when receives 0, the input status is true; when receives 1, the input status is false
594	Default status after bus voltage recovery	-(True) -False	<i>Set the default status of external telegram after voltage recovery.</i>
595	1byte threshold(0..255)	0..(100)..255	<i>Set the threshold value of 1 byte</i>
596	Quiver:<(threshold-n) or >(threshold+n) on false	0..(1)..255	<i>Set the quiver value for threshold, when it receives the value &lt;threshold-n or &gt;threshold+n, the input status is false</i>
597	Extern telegram status	-(True if REV value>=Threshold, else False) -True if REV value<=Threshold, else False	<b>True if REV value &gt;= threshold, else False:</b> when external telegram value >= threshold, the input status is true, else is false. <b>True if REV value &lt;= threshold, else False:</b> when external telegram value <= threshold, the input status is true, else is false.
598	Default status after bus voltage recovery	-(True) -False	<i>Set the default status as true or false after voltage recovery.</i>
599	2byte threshold(0..65535)	0..(1000)..65535	<i>Set the threshold value of 2 bytes</i>
600	Quiver:<(threshold-n) or >(threshold+n) on false	0..(1)..255	<i>Set the quiver value for threshold, when it receives the value &lt;threshold-n or &gt;threshold+n, the input status is false</i>
601	Extern telegram status	-(True if REV value>=Threshold, else False) -True if REV value<=Threshold, else False	<b>True if REV value &gt;= threshold, else False:</b> when external telegram value >= threshold, the input status is true, else is false. <b>True if REV value &lt;= threshold, else False:</b> when external telegram value <= threshold, the input status is true, else is false.
602	Default status after bus voltage recovery	-(True) -False	<i>Set the default status as true or false after voltage recovery.</i>
603	2bytes float threshold(0..3000)	0..(100)..3000	<i>Set the threshold value of 2 bytes float</i>
604	Quiver:<(threshold-n) or >(threshold+n) on false	0..(1)..255	<i>Set the quiver value for threshold, when it receives the value &lt;threshold-n</i>

			<i>or &gt;threshold+n, the input status is false</i>
605	Extern telegram status	-(True if REV value>=Threshold, else False) -True if REV value<=Threshold, else False	<b>True if REV value &gt;= threshold, else False:</b> when external telegram value >= threshold, the input status is true, else is false. <b>True if REV value &lt;= threshold, else False:</b> when external telegram value <= threshold, the input status is true, else is false.
606	Default status after bus voltage recovery	-(True) -False	<i>Set the default status as true or false after voltage recovery.</i>
607	4bytes threshold (0..2147483647)	0..(1000000).. 2147483647	<i>Set the threshold value of 4 bytes</i>
608	Quiver:<(threshold-n) or >(threshold+n) on false	0..(1)..255	<i>Set the quiver value for threshold, when it receives the value &lt;threshold-n or &gt;threshold+n, the input status is false</i>
609	Extern telegram status	-(True if REV value>=Threshold, else False) -True if REV value<=Threshold, else False	<b>True if REV value &gt;= threshold, else False:</b> when external telegram value >= threshold, the input status is true, else is false. <b>True if REV value &lt;= threshold, else False:</b> when external telegram value <= threshold, the input status is true, else is false.
610	Default status after bus voltage recovery	-(True) -False	<i>Set the default status as true or false after voltage recovery.</i>
611	Logical relation of Block A-D	-(AND) -OR	<i>Set the logical relation of the block</i>
612	Result of logic A-D inverted	-(No) -Yes	<b>NO:</b> will not invert the block's logic status <b>YES:</b> will invert the block's logic status
613	Enable/Disable logical function via bus	-(No) -Yes	<b>No:</b> can not change logic function via bus <b>Yes:</b> when receives 1, enable the logic function; when receives 0, disable logic function

### 3.3\_Logic function E

No.	ETS-Parameter	Range (default)	Description
614	Enable logical block E	-(Disable) -Enable	<b>Disable:</b> disable the logic block E function <b>Enable:</b> enable the logic block E function
615	Enable logic A	-(Disable) -Enable	Enable/disable the logic A to be one logic input
616	Result of logic A inverted	-(No) -Yes	<b>NO:</b> will not invert block A's logic status <b>YES:</b> will invert block A's logic status
617	Logical relation of logic A to next	-AND -OR -(Invalid)	Set the logic relation between logic A and the next logic block
618	Enable logic B	-(Disable) -Enable	Enable/disable the logic B to be one logic input
619	Result of logic B inverted	-(No) -Yes	<b>NO:</b> will not invert block B's logic status <b>YES:</b> will invert block B's logic status
620	Logical relation of logic B to next	-AND -OR -(Invalid)	Set the logic relation between logic B and the next logic block
621	Enable logic C	-(Disable) -Enable	Enable/disable the logic C to be one logic input
622	Result of logic C inverted	-(No) -Yes	<b>NO:</b> will not invert block C's logic status <b>YES:</b> will invert block C's logic status
623	Logical relation of logic C to next	-AND -OR -(Invalid)	Set the logic relation between logic C and the next logic block
624	Enable logic D	-(Disable) -Enable	Enable/disable the logic D to be one logic input
625	Result of logic D inverted	-(No) -Yes	<b>NO:</b> will not invert block D's logic status <b>YES:</b> will invert block D's logic status
626	Logical relation of logic D to next	-AND -OR -(Invalid)	Set the logic relation between logic D and the next logic block
627	Result of logic E inverted	-(No) -Yes	<b>NO:</b> will not invert block E's logic status <b>YES:</b> will invert block E's logic status
628	Enable/Disable logical	-(No)	<b>No:</b> can not change logic function via bus



	function via bus	-Yes	<b>Yes:</b> when receives 1, enable the logic function; when receives 0, disable logic function
629	Logic E output status when disabled	-(Lock status) -True -False	Set the logic output status when disable the logic E <b>Lock status:</b> keep the last time's status <b>True:</b> set the logic status to be true <b>False:</b> set the logic status to be false

3.4\_Block A-E

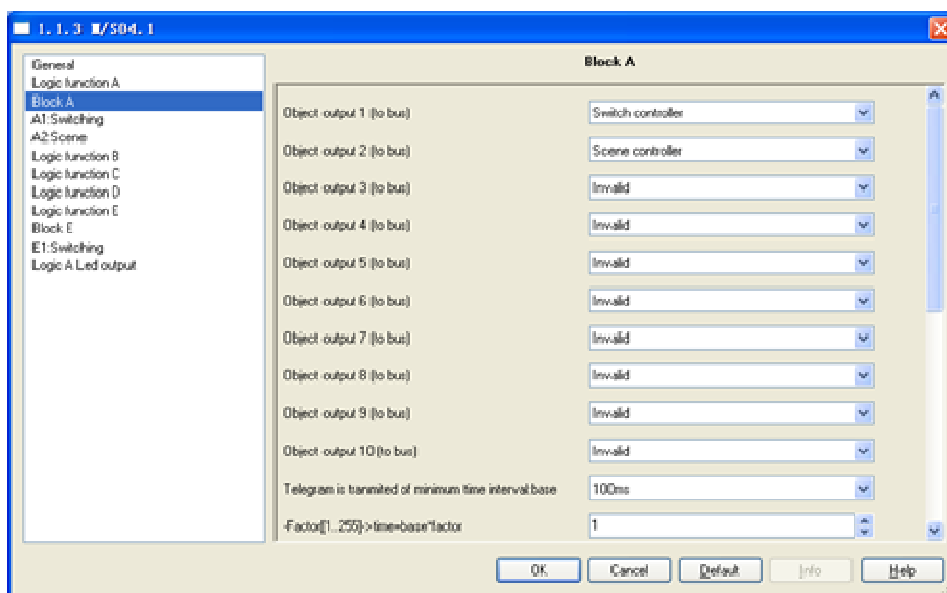

No.	ETS-Parameter	Range (default)	Description
630	Object output 1-10 (to bus)	-(Invalid) -Switch controller -Alarm controller -Shutter controller -Scene controller -Sequence controller -Percentage controller -Threshold controller -String (14bytes) controller	Select the output type for logic control
631	Telegram is transmitted of minimum time interval: base	10ms..(100ms)..1hour	Set the time base of minimum time interval to transmit the telegram
632	Factor[1..255]->time=base*factor	(1)..255	Set the time factor of minimum time interval to transmit the telegram, the minimum time interval=base*factor
633	Repeat to transmit the telegram enable	-(No) -Yes	<b>No:</b> disable the repeat transmission function <b>Yes:</b> repeat to transmit the telegram
634	Transmit telegram on	-True -False	Set the telegram type to transmit <b>True:</b> only transmit the true telegram

		-(True and False)	<b>False:</b> only transmit the false telegram <b>True and false:</b> transmit the true and false telegram
635	Transmit time interval(2..255min)	(2)..255	Set the time interval to transmit the telegram
<b>3.4.1_A-E 0..10: Switching</b>			
636	The status after bus voltage recovery	-Invalid -ON -OFF -Recovery -(According to logical status)	Set the switch status after bus voltage recovery <b>Invalid:</b> the status is invalid <b>ON:</b> will switch ON the channel after bus voltage recovery. <b>OFF:</b> will switch OFF the channel after bus voltage recovery. <b>Recovery:</b> restore the switch status before power off <b>According to logical status:</b> if logical status is true, trigger the action which set in logical output when true; if logical status is false, trigger the action which set in logical output when false.
637	Logical block output when TRUE	-Invalid -Toggle -(ON) -OFF	Set the switch output function when true <b>Invalid:</b> the switch output is invalid <b>Toggle:</b> It will invert the last time's value then send itout when true <b>ON:</b> The value it will send is 1 when true <b>OFF:</b> The value it will send is 0 when true
638	Time delay for logical block when TRUE (0..65535s)	(0)..65535	Set the delay time to send out the control telegram when true
639	Logical block output when FALSE	-Invalid -Toggle -ON -(OFF)	Set the switch output function when false <b>Invalid:</b> the switch output is invalid <b>Toggle:</b> It will invert the last time's value then send itout when false <b>ON:</b> The value it will send is 1 when false <b>OFF:</b> The value it will send is 0 when false
640	Time delay for logical block when FALSE (0..65535s)	(0)..65535	Set the delay time to send out the control telegram when false
<b>3.4.2_A-E 1..10: Alarm</b>			
641	The status after bus voltage recovery	-Invalid -Alarm -No alarm -Recovery -(According to logical status)	Set the alarm status after bus voltage recovery <b>Invalid:</b> the status is invalid <b>Alarm:</b> will send alarm telegram after bus voltage recovery. <b>No Alarm:</b> will send no alarm telegram after bus voltage recovery. <b>Recovery:</b> restore the alarm status before power off <b>According to logical status:</b> if logical status is true, trigger the action which set in logical output when true; if logical status is false, trigger the action which set in logical output when false.
642	Logical block output when TRUE	-Invalid -Toggle -(Alarm) -No Alarm	Set the alarm output function when true <b>Invalid:</b> the alarm output is invalid <b>Toggle:</b> It will invert the last time's value then send itout when true

			<p><b>Alarm:</b> The value it will send is 1 when true</p> <p><b>No Alarm:</b> The value it will send is 0 when true</p>
643	Time delay for logical block when TRUE (0..65535s)	(0)..65535	Set the delay time to send out the control telegram when true
644	Logical block output when FALSE	-Invalid -Toggle -Alarm -(No Alarm)	<p>Set the alarm output function when false</p> <p><b>Invalid:</b> the alarm output is invalid</p> <p><b>Toggle:</b> It will invert the last time's value then send it out when false</p> <p><b>Alarm:</b> The value it will send is 1 when false</p> <p><b>No Alarm:</b> The value it will send is 0 when false</p>
645	Time delay for logical block when FALSE (0..65535s)	(0)..65535	Set the delay time to send out the control telegram when false
<b>3.4.3 A-E 1..10: Shutter</b>			
646	The status after bus voltage recovery	-Invalid -UP -DOWN -Recovery -(According to logical status)	<p>Set the shutter status after bus voltage recovery</p> <p><b>Invalid:</b> the status is invalid</p> <p><b>UP:</b> will send up telegram after bus voltage recovery.</p> <p><b>DOWN:</b> will send down telegram after bus voltage recovery.</p> <p><b>Recovery:</b> restore the shutter status before power off</p> <p><b>According to logical status:</b> if logical status is true, trigger the action which set in logical output when true; if logical status is false, trigger the action which set in logical output when false.</p>
647	Logical block output when TRUE	-Invalid -Toggle -(UP) -DOWN	<p>Set the shutter output function when true</p> <p><b>Invalid:</b> the shutter output is invalid</p> <p><b>Toggle:</b> It will send up/down telegram when true</p> <p><b>UP:</b> it will send move up telegram when true</p> <p><b>DOWN:</b> it will send move down telegram when true</p>
648	Time delay for logical block when TRUE (0..65535s)	(0)..65535	Set the delay time to send out the control telegram when true
649	Logical block output when FALSE	-Invalid -Toggle -UP -(DOWN)	<p>Set the shutter output function when false</p> <p><b>Invalid:</b> the shutter output is invalid</p> <p><b>Toggle:</b> It will send up/down telegram when false</p> <p><b>UP:</b> it will send move up telegram when false</p> <p><b>DOWN:</b> it will send move down telegram when false</p>
650	Time delay for logical block when FALSE (0..65535s)	(0)..65535	Set the delay time to send out the control telegram when false
<b>3.4.4 A-E 1..10: Scene</b>			
651	The status after bus voltage recovery	-Invalid -Defined scene -Recovery -(According to logical status)	<p>Set the output scene after bus voltage recovery</p> <p><b>Invalid:</b> the scene output is invalid</p> <p><b>Defined scene:</b> will output defined scene</p>

		status)	<p>after bus voltage recovery.  <b>Recovery:</b> restore the scene before power off  <b>According to logical status:</b>if logical status is true, trigger the action which set in logical output when true; if logical status is false, trigger the action which set in logical output when false.</p>
652	Recovery defined scene NO.	(Scene NO.01)..Scene NO.64	Set the output scene number for defined scene option
653	Logical block output when TRUE	(Scene NO.01)..Scene NO.64	Set the output scene number when true
654	Time delay for logical block when TRUE (0..65535s)	(0)..65535	Set the delay time to send out the control telegram when true
655	Logical block output when FALSE	-Invalid -Scene NO.01..(Scene NO.2)..Scene NO.64	Set the output scene number when false
656	Time delay for logical block when FALSE (0..65535s)	(0)..65535	Set the delay time to send out the control telegram when false
<b>3.4.5 A-E 1..10: Sequence</b>			
657	The status after bus voltage recovery	-Invalid -Start -Stop -Recovery -(According to logical status)	<p>Set the output sequence after bus voltage recovery  <b>Invalid:</b> the sequence output is invalid  <b>Start:</b> will send telegram 1 to start the sequence after bus voltage recovery.  <b>Stop:</b> will send telegram 0 to stop the sequence after bus voltage recovery.  <b>Recovery:</b> restore the sequence status before power off  <b>According to logical status:</b>if logical status is true, trigger the action which set in logical output when true; if logical status is false, trigger the action which set in logical output when false.</p>
658	Logical block output when TRUE	-Invalid -Toggle -(Start) -Stop	<p>Set the sequence output function when true  <b>Invalid:</b> the sequence output is invalid  <b>Toggle:</b>It will invert the last time's value then send itout when true  <b>Start:</b> will send telegram 1 to start the sequence when true  <b>Stop:</b> will send telegram 0 to stop the sequence when true</p>
659	Time delay for logical block when TRUE (0..65535s)	(0)..65535	Set the delay time to send out the control telegram when true
660	Logical block output when FALSE	-Invalid -Toggle -Start -(Stop)	<p>Set the sequence output function when false  <b>Invalid:</b> the sequence output is invalid  <b>Toggle:</b>It will invert the last time's value then send itout when false  <b>Start:</b> will send telegram 1 to start the sequence when false  <b>Stop:</b> will send telegram 0 to stop the sequence when false</p>
661	Time delay for logical block when FALSE (0..65535s)	(0)..65535	Set the delay time to send out the control telegram when false

3.4.6 A-E 1..10: Percentage			
662	The status after bus voltage recovery	-Invalid -Defined percentage -Recovery -(According to logical status)	Set the output percentage after bus voltage recovery <b>Invalid:</b> the percentage output is invalid <b>Defined percentage:</b> will output defined percentage value after bus voltage recovery. <b>Recovery:</b> restore the percentage value before power off <b>According to logical status:</b> if logical status is true, trigger the action which set in logical output when true; if logical status is false, trigger the action which set in logical output when false.
663	Recovery defined percentage	(0%(0)..100%(255))	Set the output percentage value for defined percentage option
664	Logical block output when TRUE	Invalid, 0%(0)..(100%(255))	Set the output percentage value when true
665	Time delay for logical block when TRUE (0..65535s)	(0)..65535	Set the delay time to send out the control telegram when true
666	Logical block output when FALSE	Invalid, (0%(0)..100%(255))	Set the output percentage value when false
667	Time delay for logical block when FALSE (0..65535s)	(0)..65535	Set the delay time to send out the control telegram when false
3.4.7 A-E 1..10: Threshold			
668	Threshold control type	-(1byte threshold) -2bytes threshold	Set the threshold control type
669	The status after bus voltage recovery	-Invalid -Defined threshold -Recovery -(According to logical status)	Set the output threshold value after bus voltage recovery <b>Invalid:</b> the threshold output is invalid <b>Defined threshold:</b> will output defined threshold value after bus voltage recovery. <b>Recovery:</b> restore the threshold value before power off <b>According to logical status:</b> if logical status is true, trigger the action which set in logical output when true; if logical status is false, trigger the action which set in logical output when false.
670	Recovery defined threshold (0..255)	(0)..255	Set the output threshold value for defined threshold option
671	Recovery defined threshold (0..65535)	(0)..65535	Set the output threshold value for defined threshold option
672	TRUE is valid?	-No -(Yes)	<b>No:</b> disable the logic true function <b>Yes:</b> enable the logic true function
673	Logical block output when TRUE	0..(255)	Set the output threshold value when true
674	Logical block output when TRUE	0..(1000)..65535	Set the output threshold value when true
675	Time delay for logical block when TRUE (0..65535s)	(0)..65535	Set the delay time to send out the control telegram when true
676	FALSE is valid?	-No -(Yes)	<b>No:</b> disable the logic false function <b>Yes:</b> enable the logic false function
677	Logical block output when FALSE	(0)..255	Set the output threshold value when false

678	Logical block output when FALSE	(0)..65535	Set the output threshold value when false
679	Time delay for logical block when FALSE (0..65535s)	(0)..65535	Set the delay time to send out the control telegram when false
<b>3.4.8 A-E 1..10: String(14bytes)</b>			
680	The status after bus voltage recovery	-Invalid -Defined string -(According to logical status)	Set the output string content after bus voltage recovery <b>Invalid:</b> the string output is invalid <b>Defined string:</b> will output defined string content after bus voltage recovery. <b>Recovery:</b> restore the string content before power off <b>According to logical status:</b> if logical status is true, trigger the action which set in logical output when true; if logical status is false, trigger the action which set in logical output when false.
681	Recovery defined string	(Hello world!)	Set the output string content for defined string option
682	TRUE is valid?	-No -(Yes)	<b>No:</b> disable the logic true function <b>Yes:</b> enable the logic true function
683	Logical block output when TRUE	(Hello world!)	Set the output string content when true
684	Time delay for logical block when TRUE (0..65535s)	(0)..65535	Set the delay time to send out the control telegram when true
685	FALSE is valid?	-No -(Yes)	<b>No:</b> disable the logic false function <b>Yes:</b> enable the logic false function
686	Logical block output when FALSE	(Hello world!)	Set the output string content when false
687	Time delay for logical block when FALSE (0..65535s)	(0)..65535	Set the delay time to send out the control telegram when false

XX

**4.0 Dimming controller**

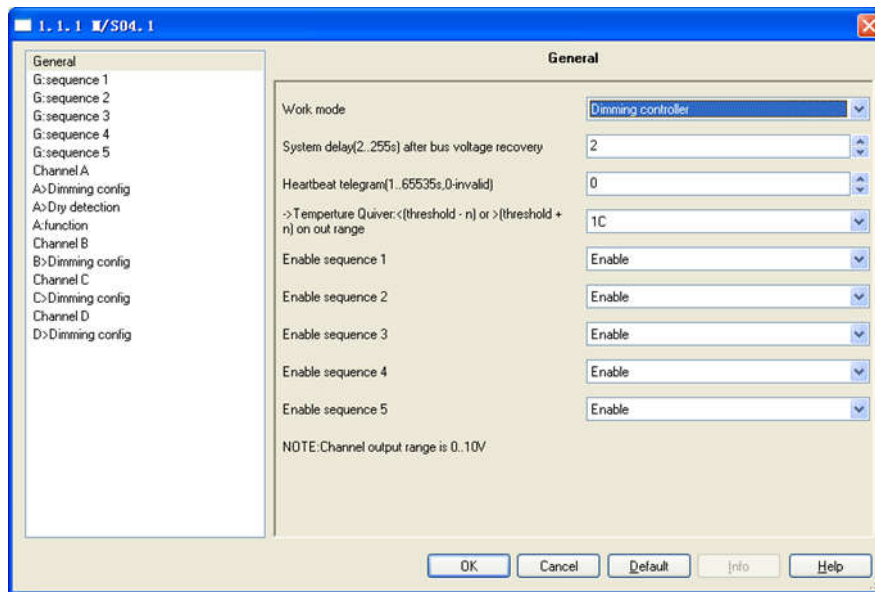

No.	ETS-Parameter	Range (default)	Description
688	Work mode	- (Sensors controller) - Logical controller <b>- Dimming controller</b>	Set the work mode- dimming controller
689	System delay (2-255s) after bus voltage recovery	(2)..255s	Set the delay time for the device to work after power on, the range is 2-255s
690	Heartbeat telegram (1..65535s,0-invalid)	(0)..65535s	If the parameter is set to nonzero, the device will send a telegram data (alternately between 0 and 1) cyclically after time out; if it's set to 0, this function is invalid.
691	Temperature Quiver: < (threshold - n) or >(threshold +n) on out range)	0C, (1C),..10C	The effective range is larger than threshold1 and less than threshold2 The setting range is larger than the (threshold1-n) and less than (threshold2+n). Suppose the temperature is in the effective range, when it changes within the setting range, the status will not change. Suppose the temperature is in the effective range, when it changes out of the setting range, the status will change. Suppose the temperature is not in the effective range, only when the temperature changes into the effective range, the status will change.
692	Enable sequence 1-5	-(Disable) -Enable	<b>Disable:</b> sequence function is invalid <b>Enable:</b> enable the sequence control function

**4.1 G: sequence 1-5**

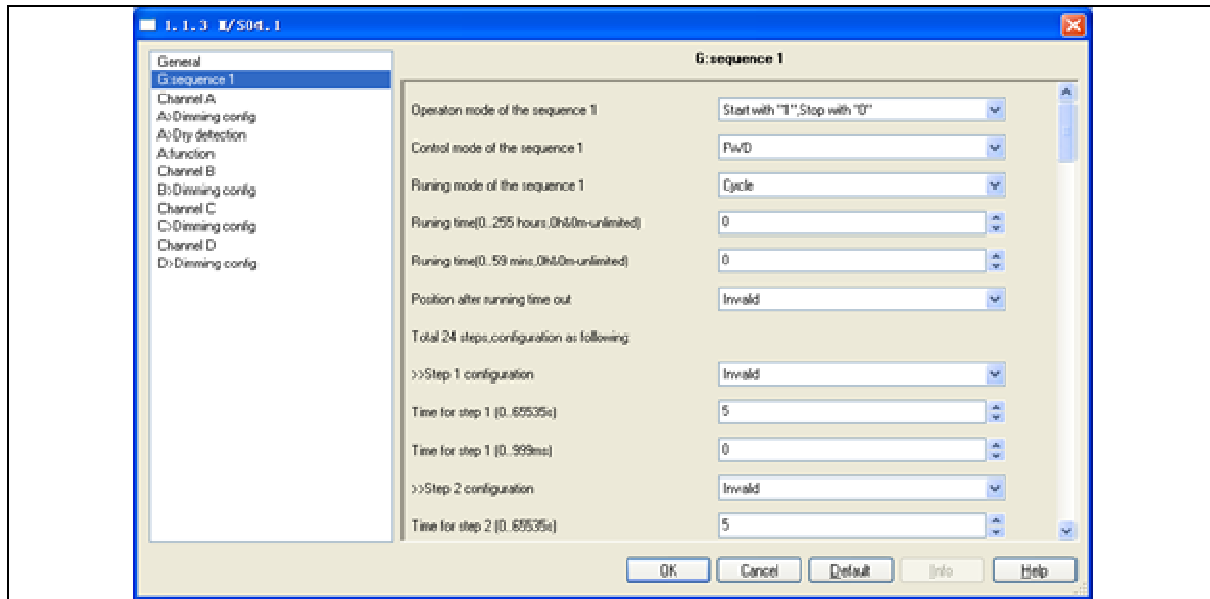

No.	ETS-Parameter	Range (default)	Description
693	Operation mode of the sequence 1-5	-(Start with "1", Stop with "0") -Start with "0", Stop with "1" -Start with "1/0", can't stop	<b>Start with "1", Stop with "0"</b> : When receives "1", run the sequence; When receives 0, stop the sequence. <b>Start with "0", Stop with "1"</b> : when receives 0, run the sequence; When receives 1, stop the sequence. <b>Start with "1/0", can't stop</b> : whether receives 1 or 0, run the sequence.
694	Control mode of the sequence 1-5	-(FWD) -REW -Random	<b>FWD</b> : Forward mode <b>REW</b> : Back work mode <b>RANDOM</b> : Random mode
695	Running mode of the sequence 1-5	-Single -(Cycle)	<b>Single</b> : Run only one time <b>Cycle</b> : run the sequence cyclically
696	Running time(0...255hours, 0h&0m-unlimited)	(0)..255	Set the sequence running time(0-255h), after the time, it will stop running automatically. if the time is set to 0h&0m, then the running time is unlimited.
697	Running time(0...59mins, 0h&0m-unlimited)	(0)..59	Set the sequence running time(0-59min), after the time, it will stop running automatically. if the time is set to 0h&0m, then the running time is unlimited.
698	Position after time out	-(Invalid) -Scene NO.1..Scene NO.64	If the sequence running in Cycle mode, and the run time is greater than zero, After time out, the sequence will call the defined scene.
699	Step1..24 configuration	-(Invalid) -Scene NO.1..Scene NO.64	Set the running scene for each step, one sequence can have up to 24 steps
700	Time for step 1..24 (0...65535s)	0..(5)..65535	Set the running time(0-65535s) for each step.
701	Time for step 1(0...999ms)	(0)..999	Set the running time(0-999ms) for each step.

**4.2 Channel A-D**



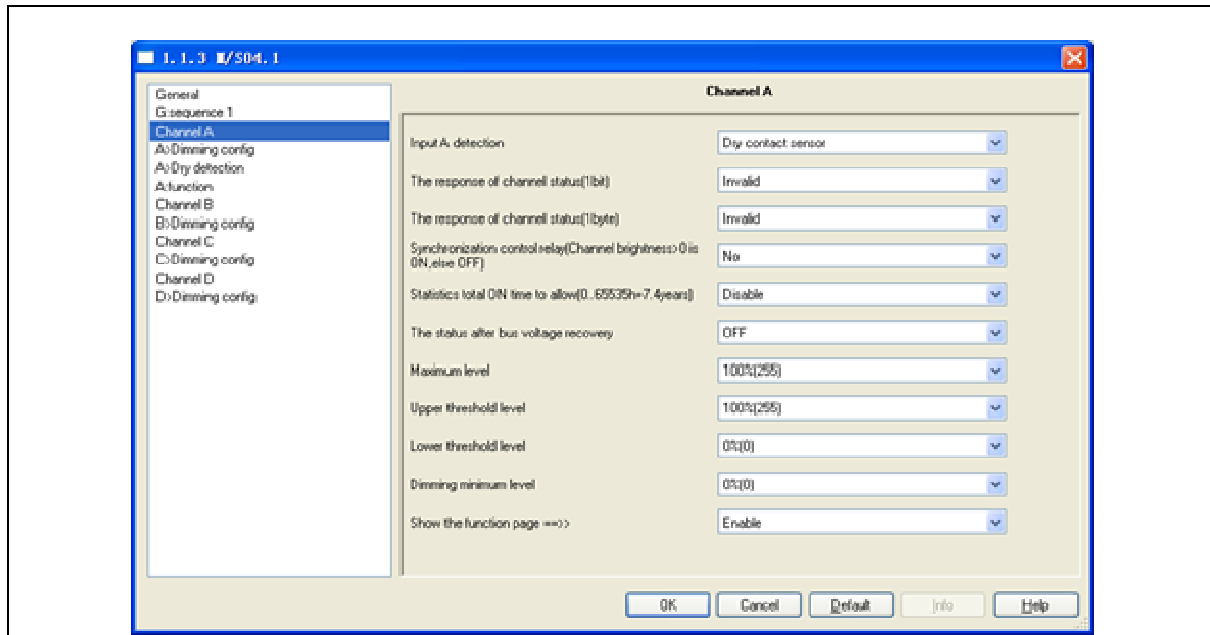

No.	ETS-Parameter	Range (default)	Description
702	Input A-D detection	-(No detection) -Dry contact sensor -Temperature sensor	<b>No detection:</b> Input type is invalid. <b>Dry contact:</b> input type is dry contact sensor <b>Temperature sensor:</b> input type is temperature sensor
703	The response of channel status(1bit)	-(Invalid) -1bit always response -1bit only changed	<b>1 bit always response:</b> it will always report status to bus, If the brightness>0, report telegram 1 If the brightness=0, report telegram0 <b>1 bit only changed:</b> it will report when the brightness change from nonzero(zero) to zero (nonzero).
704	The response of channel status(1byte)	-(Invalid) -1byte always response -1byte only changed	<b>1 byte always response:</b> it will always report the brightness value to bus. <b>1 byte only changed:</b> it will report the brightness value to bus only when change
705	Synchronization control relay (Channel brightness>0 is ON, else OFF)	-(No) -Yes	Use to control the relay, when receives the brightness>0 telegram, switch on the relay; when receives the brightness=0 telegram, switch off the relay. It's specially used to shut down the ballast completely with the help of relay.
706	Statistics total ON time to allow (0..65535h=7.4years)	-(Disable) -Enable	This function is used to calculate the total ON time for channel output, the maximum time is 65535h. This function is very useful, because user can know channel work status through this function. <b>Disable:</b> don't timing. <b>Enable:</b> enable statistics time function.
707	Alarm when time out (1...65535h,0-invalid)		When the device's operating time arrives the setting value will send alarm telegram.

708	Transmit telegram interval when alarm (1..255s)		Set the time interval to transmit the alarm telegram.
709	The status after bus voltage recovery	- (OFF) - Defined brightness value - Last brightness value	<b>OFF:</b> the channel's status is off after bus voltage recovery <b>Defined brightness value:</b> the channel's status is set to defined brightness value after bus voltage recovery <b>Last brightness value:</b> the channel's status will restore to last brightness value before power off
710	Brightness value	(0%(0))..100%(255)	Set the output brightness value for defined brightness value option.
711	Maximum level	0%(0)..(100%(255))	Set the maximum level.
712	Upper threshold level	0%(0)..(100%(255))	Set the upper threshold level.
713	Lower threshold level	(0%(0))..100%(255)	Set the lower threshold level.
714	Dimming minimum level	(0%(0))..100%(255)	Set the dimming minimum level.
715	Show the function page	- (Disable) - Enable	<b>Disable:</b> Don't show the function page about dimmer. <b>Enable:</b> Show the function page, the page is used to set the function about dimmer.

4.3 A-D Dimming config

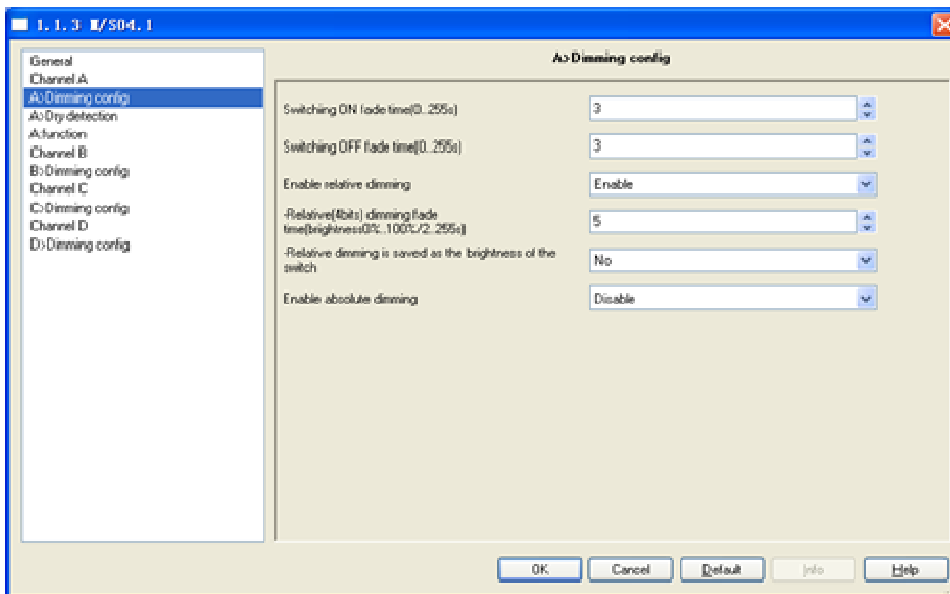

No.	ETS-Parameter	Range (default)	Description
716	Switching ON fade time(0...255s)	0..(3)..255	Set the fade time to switch on. It will take the setting time to change value from 0% to 100%.

717	Switching OFF fade time(0...255s)	0..(3)..255	Set the fade time to switch off. It will take the setting time to change value from 100% to 0%.
718	Enable relative dimming	-Disable -(Enable)	<b>Disable:</b> disable the relative dimming function <b>Enable:</b> enable the relative dimming function
719	Relative(4bits) dimming fade time (brightness 0%..100%/2..255s)	2..(5)..255	Set the fade time for relative dimming. It will takes the setting time to change value from 0%(100%) to 100%(0%).
720	Relative dimming is saved as the brightness of the switch	-No -(Yes)	<b>No:</b> when turn on light, the brightness will go to 100%. <b>Yes:</b> when turn on light, the brightness will go to last dimming brightness before turn off
721	Enable absolute dimming	-Disable -(Enable)	<b>Disable:</b> disable the absolute dimming function <b>Enable:</b> enable the absolute dimming function
722	Absolute(1byte) dimming fade time (brightness 0%..100%/0..255s)	0..(5)..255	Set the fade time for absolute dimming. It will takes the setting time to change value from 0%(100%) to 100%(0%).
723	Absolute dimming is saved as the brightness of the switch	-No -(Yes)	<b>No:</b> when turn on light, the brightness will go to 100%. <b>Yes:</b> when turn on light, the brightness will go to last brightness before turn off

4.4 A-D:function

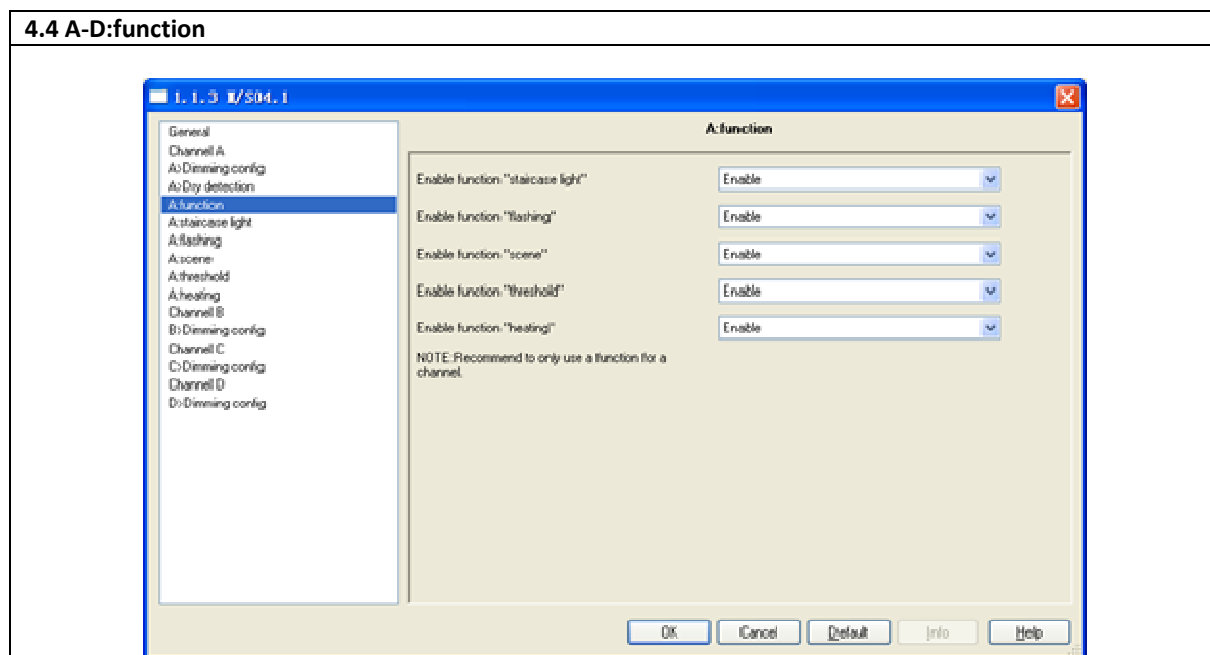

No.	ETS-Parameter	Range (default)	Description
724	Enable function 'staircase light'	-(Disable) -Enable	<b>Disable:</b> the staircase light function is invalid <b>Enable:</b> the staircase light function is valid
725	Enable function 'flashing'	-(Disable) -Enable	<b>Disable:</b> the flashing function is invalid <b>Enable:</b> the flashing function is valid
726	Enable function 'scene'	-(Disable) -Enable	<b>Disable:</b> the scene function is invalid <b>Enable:</b> the scene light function is valid
727	Enable function 'threshold'	-(Disable) -Enable	<b>Disable:</b> the threshold function is invalid <b>Enable:</b> the threshold function is valid
728	Enable function 'heating'	-(Disable) -Enable	<b>Disable:</b> the heating function is invalid <b>Enable:</b> the heating light function is valid

4.5 A-D:staircase light

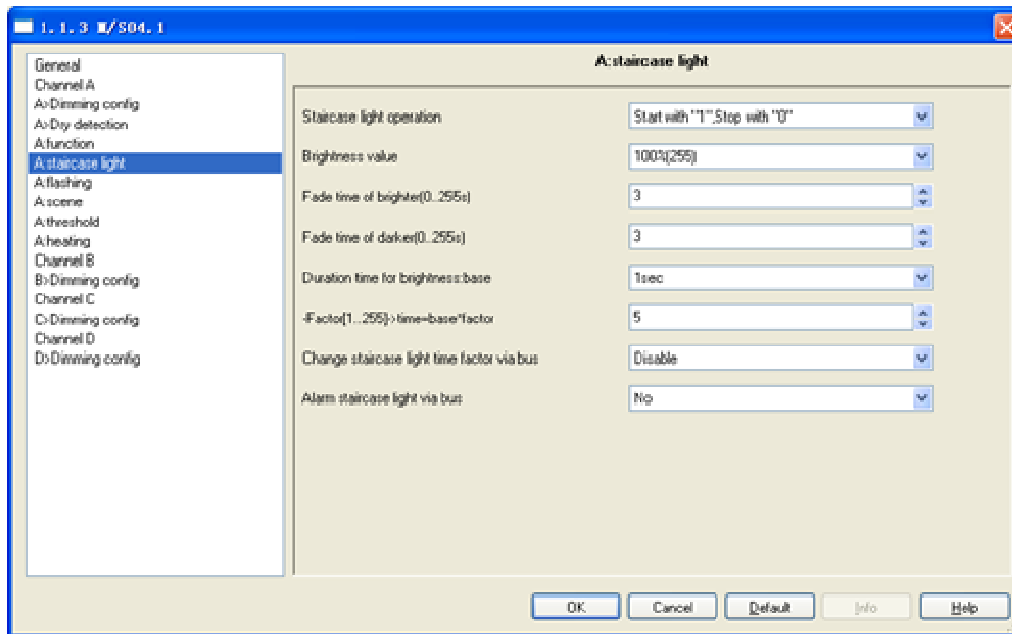

No.	ETS-Parameter	Range (default)	Description
729	Staircase light operation	-(Start with "1", stop with "0") -Start with "1", invalid with "0" -Start with "1/0", can't stop	<b>Start with "1", Stop with "0":</b> When receives "1", run the staircase light; When receives 0, stop it. <b>Start with "0", Stop with "1":</b> when receives 0, run the staircase light; When receives 1, stop it. <b>Start with "1/0", can't stop:</b> whether receives 1 or 0, run the staircase light.
730	Brightness value	0%(0)..(100%(255))	Set the brightness value for staircase light.
731	Fade time of brighter(0...255s)	0..(3)..255	Set the fade time to switch on. It will take the setting time to change value

			from 0% to 100%.
732	Fade time of darker(0...255s)	0..(3)..255	Set the fade time to switch off. It will take the setting time to change value from 100% to 0%.
733	Duration time for brightness: base	-(1sec) -1min -1hour	Set the duration time for staircase light, it will auto off after this time. Duration time=base*factor.
734	Factor[1..255]->time=base*factor	1..(5)..255	Set the duration time for staircase light, it will auto off after this time. Duration time=base*factor.
735	Change staircase lighting time factor via bus	-(Disable) -Enable	<b>Disable:</b> Can't modify staircase light duration time factor via bus, only can be set in database. <b>Enable:</b> allow to modify staircase light duration time factor via bus.
736	Alarm staircase light via bus	-(No) -Yes	<b>NO:</b> will not send out alarm telegram when trigger the staircase light <b>YES:</b> will send out alarm telegram when trigger the staircase light

4.6 A-D:flashing

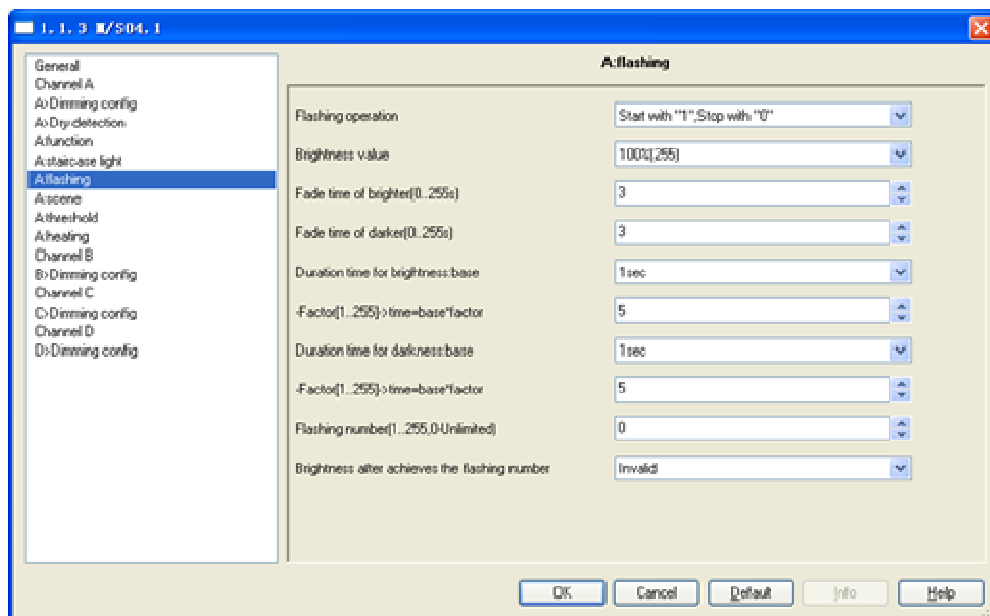

No.	ETS-Parameter	Range (default)	Description
737	Flashing operation	-(Start with "1", stop with "0") -Start with "0", stop with "1" -Start with "1/0", can't stop	<b>Start with "1", Stop with "0":</b> When receives "1", run the flashing function; When receives 0, stop it. <b>Start with "0", Stop with "1":</b> when receives 0, run the flashing function; When receives 1, stop it. <b>Start with "1/0", can't stop:</b> whether receives 1 or 0, run the flashing function.
738	Brightness value	0%(0)..(100%(255))	Set the brightness value for flashing
739	Fade time of	0..(3)..255	Set the fade time to switch on. It will

	brighter(0...255s)		take the setting time to change value from 0% to 100%.
740	Fade time of darker(0...255s)	0..(3)..255	Set the fade time to switch off. It will take the setting time to change value from 100% to 0%.
741	Duration time for brightness: base	-(1sec) -1min -1hour	Set the duration time for on, it will auto off after this time. Duration time=base*factor.
742	Factor[1..255]->time=base*factor	1..(5)..255	Set the duration time for on, it will auto off after this time. Duration time=base*factor.
743	Duration time for darkness: base	-(1sec) -1min -1hour	Set the duration time for off, it will auto on after this time. Duration time=base*factor.
744	Factor[1..255]->time=base*factor	1..(5)..255	Set the duration time for off, it will auto on after this time. Duration time=base*factor.
745	Flashing number (1...255, 0-Unlimited)	(0)..255	Set the flashing times, it will stop flashing after achieves this times. 0-unlimited.
746	Brightness after achieves the flashing number	-(Invalid) -0%(0)..100%(255)	Set the brightness after achieves the flashing times.

**4.7 A-D:scene**

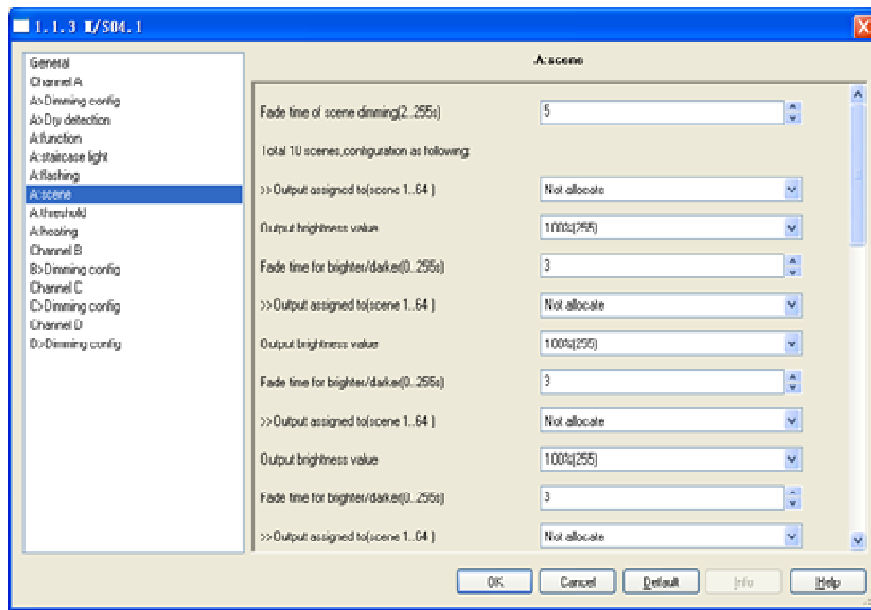

No.	ETS-Parameter	Range (default)	Description
747	Fade time of scene dimming: (2...255s)	2..(5)..255	Set the fade time for scene dimming
748	10x Output assigned to(scene 1..64)	-(Not allocated) -Scene NO.1..Scene NO.64	Allocate the scenes for different steps
749	Output brightness value	-0%(0)..(100%(255))	Set the channel output brightness value for a certain scene
750	Fade time for brighter/darker (0...255s)	0..(3)..255	Set the fade time for the scene, it will take the setting time to change from one scene to another

#### 4.8 A-D:threshold

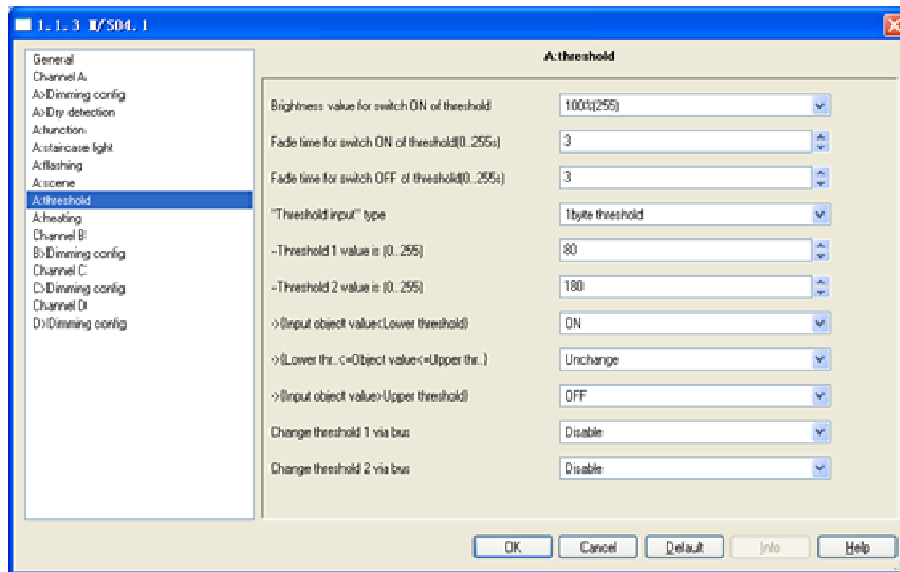

No.	ETS-Parameter	Range (default)	Description
751	Brightness value for switch ON of threshold	0%(0)..(100%(255))	Set the brightness for switch on of threshold
752	Fade time for switch ON of threshold (0...255s)	0..(3)..255	Set the fade time to switch on, it will takes the setting time to change value from 0% to 100%.
753	Fade time for switch OFF of threshold (0...255s)	0..(3)..255	Set the fade time to switch off. It will takes the setting time to change value from 100% to 0%.
754	'Threshold input' type	-(1byte threshold) -2bytes threshold	Set the type of threshold.
755	Threshold 1 value is (0...255)	0..(80)..255	Set threshold 1 value
756	Threshold 1 value is (0...65535)	0..(10000)..65535	Set threshold 1 value
757	Threshold 2 value is (0...255)	0..(180)..255	Set threshold 2 value
758	Threshold 2 value is (0...65535)	0..(30000)..65535	Set threshold 2 value
759	(Input object value<Lower threshold)	-Unchange -(ON) -OFF	If input value< lower threshold, the switch will do the action according to below setting: <b>Unchange:</b> The channel switch position will not change. <b>ON:</b> The channel switch position will set to ON. <b>OFF:</b> The channel switch position will set to OFF
760	(Lower threshold<=Input value<=Upper threshold)	-(Unchange) -ON -OFF	If lower threshold <=input value<=upper threshold, the switch will do the action according to below setting: <b>Unchange:</b> The channel switch position will not change. <b>ON:</b> The channel switch position will

			<p>set to ON.  <b>OFF:</b> The channel switch position will set to OFF</p>
761	(Input value>Upper threshold)	-Unchange -ON -(OFF)	<p>If upper threshold &lt;input value, the switch will do the action according to below setting:  <b>Unchange:</b> The channel switch position will not change.  <b>ON:</b> The channel switch position will set to ON.  <b>OFF:</b> The channel switch position will set to OFF</p>
762	Change threshold 1 via bus	-(Disable) -Enable	<p><b>Disable:</b> do not allow to change the threshold 1 value from bus.  <b>Enable:</b> Allow to change the threshold 1 value from bus.</p>
763	Change threshold 2 via bus	-(Disable) -Enable	<p><b>Disable:</b> do not allow to change the threshold 2 value from bus.  <b>Enable:</b> Allow to change the threshold 2 value from bus.</p>

4.9 A-D:heating

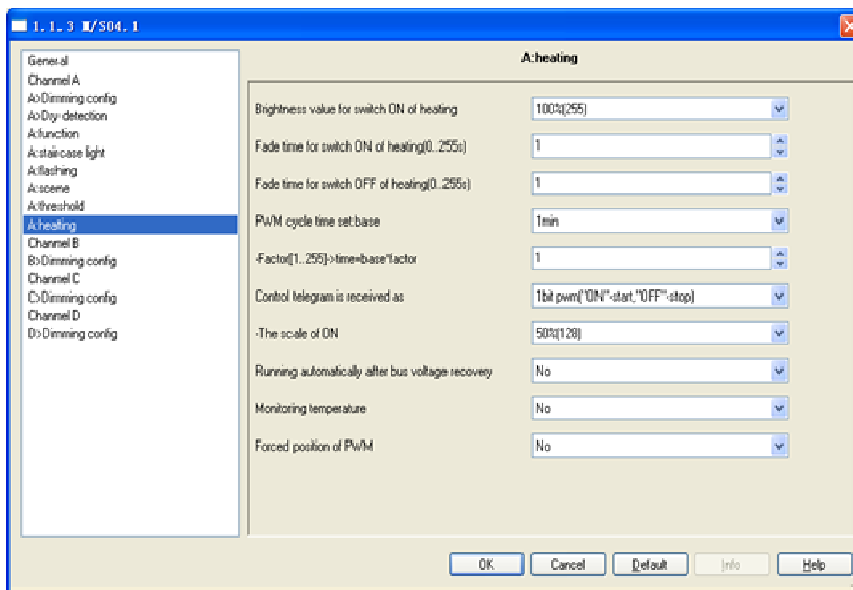

No.	ETS-Parameter	Range (default)	Description
764	Brightness value for switch ON of heating	0%(0)..(100%(255))	Set the brightness(working power)for switch on of heating
765	Fade time for switch ON of heating (0...255s)	0..(1)..255	Set the fade time to switch on, it will takes the setting time to change value from 0% to 100%.
766	Fade time for switch OFF of heating (0...255s)	0..(1)..255	Set the fade time to switch off. It will takes the setting time to change value from 100% to 0%.
767	PWM cycle time set: base	-(1min) -1hour	Set the PWM cycle time, the cycle time =base*factor
768	Factor[1..255]->time=base*factor	(1)..255	Set the PWM cycle time, the cycle time =base*factor



769	Control telegram is received as	-1bit pwm(ON-start/OFF-stop) -1byte("255"-ON/"0"-OFF/ other valve)	<b>1bit PWM(1-start/0-stop):</b> when receives 1, will switch on for heating; when receives 0, will switch off. <b>1byte(255-ON/0-OFF/other valve):</b> will switch on for heating when receives 255; will switch off when receives 0; will open to the corresponding pulse width of PWM according to the value of receiving other value (1-254)
770	The scale of ON	0%(OFF)..(50%(128)..100%(ON)	Set the pulse width of PWM to work for 1 bit PWM
771	Running automatically after bus voltage recovery	-(No) -Defined valve -Recovery	<b>NO:</b> will not run automatically <b>Defined value:</b> open to the defined pulse width of PWM <b>Recovery:</b> will recovery to the corresponding position before power off
772	Position of the valve	0%(OFF)..(50%(128)..100%(ON)	Set the pulse width of PWM for defined value
773	Monitoring temperature	-(No) -Yes	<b>No:</b> will not monitor the temperature <b>Yes:</b> will monitor the temperature
774	Monitor cycles(1..255min)	0..(5)..255	Set the time interval to monitor the temperature
775	Get temperature from (If local, input select temperature detection)	-(Local) -Bus	Set the temperature source for heating <b>Local:</b> need to connect temperature sensor for the current input channel to detect temperature <b>Bus:</b> read temperature from another device
776	Bus temperature compensation(-5C..+5C)	-5C..(0C)..+5C	Set the compensation value to correct the temperature
777	Temperature >= Threshold1(-30C..+50C)	-30..(30)..50	Set the temperature threshold 1 value
778	Temperature <= Threshold2(-30C..+50C)	-30..(20)..50	Set the temperature threshold 2 value
779	Temperature threshold1 operation	-Invalid -ON and start PWM -(OFF and stop PWM)	Set the action when temperature reaches to the threshold 1 value <b>Invalid:</b> no action <b>ON and start PWM:</b> will switch on and start PWM <b>OFF and stop PWM:</b> will switch off and stop PWM
780	Temperature threshold1 alarm	-(No) -Yes	Set to alarm or not when temperature reaches to the threshold 1 value <b>No:</b> will not alarm <b>Yes:</b> will send alarm telegram to bus
781	Temperature threshold2 operation	-Invalid -(ON and start PWM) -OFF and stop PWM	Set the action when temperature reaches to the threshold 2 value <b>Invalid:</b> no action <b>ON and start PWM:</b> will switch on and start PWM <b>OFF and stop PWM:</b> will switch off and stop PWM
782	Temperature threshold2 alarm	-(No) -Yes	Set to alarm or not when temperature reaches to the threshold 2 value <b>No:</b> will not alarm

			<b>Yes:</b> will send alarm telegram to bus
783	Forced position of PWM	-(No) -Yes	<b>No:</b> can not forced control when running <b>Yes:</b> set the position for forced control. when receives forced control telegram, it will go to the setting position.

XX

D. Communication Objects ('Electronic switch' adjustment)

D.0 General

Objects "General" and Enable of "Input A"				
NO.	Object name	Function	Flags	Data type
0	General	Heartbeat telegram	C T	DPT 1.003 1bit
This communication object is always active and valid. Invert the value send telegram to bus in next frame. e.g. last telegram value is "1", the next telegram value is "0"				
10	Input A	1-Enable,/0-disable	C W	DPT 1.003 1bit
This communication object is used to enable/disable the input A. when receive the telegram 1, enable the input A function, when received the telegram 0, disable the input A function.				

D.1 Dry contact sensor

Objects "Switch controller"				
NO.	Object name	Function	Flags	Data type
11	Input A(short)	switching	C W T U	DPT 1.001 1bit
12	Input A(long)	switching	C W T U	DPT 1.001 1bit
These communication objects are for switching control. when short/long press the dry contact A, it will send telegrams to bus to control the output.				

**Objects “Switch/Dimming controller”**

Number	Name	Object Function	D...	G..	Length	C	R	W	T	U	Data Type	Priority
0	General	Heartbeat telegram			1 bit	C	-	-	T	-		Low
10	Input A	'1'-Enable/'0'-Disable			1 bit	C	-	W	-	-		Low
11	Input A (short)	Switching			1 bit	C	-	W	T	U		Low
12	Input A (long)	Dimming			4 bit	C	-	-	T	-		Low

NO.	Object name	Function	Flags	Data type
11	Input A(short)	Switching	C W T U	DPT 1.001 1 bit
12	Input A(long)	Dimming	C T	DPT 3.007 4 bit

*These communication objects are for relative dimming control.short press to on/off the dimmer; long press to dim the dimmer.*

**Objects “shutter controller”**

Number	Name	Object Function	D...	G..	Length	C	R	W	T	U	Data Type	Priority
0	General	Heartbeat telegram			1 bit	C	-	-	T	-		Low
10	Input A	'1'-Enable/'0'-Disable			1 bit	C	-	W	-	-		Low
11	Input A (short)	Adjust for shutter(Inc)			1 bit	C	-	W	T	U		Low
12	Input A (long)	Move for shutter(Toggle)			1 bit	C	-	W	T	U		Low

NO.	Object name	Function	Flags	Data type
11	Input A(short)	Adjust for shutter(Inc)	C W T U	DPT 1.007 1 bit
12	Input A(long)	Move for shutter(Toggle)	C W T U	DPT 1.007 1 bit

*These communication objects are for shutter control.short press to stop the shutter/adjust the louver; long press to move up/down the shutter.*

**Objects “Flexible controller”**

Number	Name	Object Function	D...	G..	Length	C	R	W	T	U	Data Type	Priority
0	General	Heartbeat telegram			1 bit	C	-	-	T	-		Low
10	Input A	'1'-Enable/'0'-Disable			1 bit	C	-	W	-	-		Low
11	Input A	Flexible			1 bit	C	-	W	T	U		Low

NO.	Object name	Function	Flags	Data type
11	Input A	Flexible	C W T U	DPT 1.001 1 bit

*This communication object is for flexible control. when control the dry contact, it will sends the defined value “1”or“0” to bus*

**Objects „Scene controller“**

Number	Name	Object Function	D...	G..	Length	C	R	W	T	U	Data Type	Priority
0	General	Heartbeat telegram			1 bit	C	-	-	T	-		Low
10	Input A	'1'-Enable/'0'-Disable			1 bit	C	-	W	-	-		Low
11	Input A (short)	Call scene			1 byte	C	-	W	T	U		Low
12	Input A (long)	Scene dimming			4 bit	C	-	-	T	-		Low

NO.	Object name	Function	Flags	Data type
-----	-------------	----------	-------	-----------

11	Input A(short)	Call scene	C W T U	DPT 18.001 1 byte
12	Input A(long)	Scene dimming	C T	DPT 3.007 4 bit

*These communication objects are for scene control. short press to call scene; long press to dim the scene*

Objects „Sequence controller“

Number	Name	Object Function	D...	G..	Length	C	R	W	T	U	Data Type	Priority
0	General	Heartbeat telegram			1 bit	C	-	-	T	-		Low
10	Input A	'1'-Enable/'0'-Disable			1 bit	C	-	Y	-	-		Low
11	Input A (short)	Sequence			1 bit	C	-	Y	T	U		Low
12	Input A (long)	Sequence			1 bit	C	-	Y	T	U		Low

NO.	Object name	Function	Flags	Data type
11	Input A(short)	Sequence	C W T U	DPT 1.010 1 bit
12	Input A(long)	Sequence		

*These communication object is for sequence control. Short/long press can trigger different sequence*

Objects „Percentage controller“

Number	Name	Object Function	D...	G..	Length	C	R	W	T	U	Data Type	Priority
0	General	Heartbeat telegram			1 bit	C	-	-	T	-		Low
10	Input A	'1'-Enable/'0'-Disable			1 bit	C	-	Y	-	-		Low
11	Input A (short)	Percentage			1 Byte	C	-	Y	T	U		Low
12	Input A (long)	Percentage			1 Byte	C	-	Y	T	U		Low

NO.	Object name	Function	Flags	Data type
11	Input A(short)	Percentage	C W T U	DPT 5.001 1 byte
12	Input A(long)	percentage		

*These communication objects are for sequence control. Short/long press can send out different percentage value*

Objects “Threshold controller“

Number	Name	Object Function	D...	G..	Length	C	R	W	T	U	Data Type	Priority
0	General	Heartbeat telegram			1 bit	C	-	-	T	-		Low
10	Input A	'1'-Enable/'0'-Disable			1 bit	C	-	W	-	-		Low
11	Input A (short)	Threshold(1byte)			1 Byte	C	-	W	T	U		Low
12	Input A (long)	Threshold(1byte)			1 Byte	C	-	W	T	U		Low

NO.	Object name	Function	Flags	Data type
11	Input A(short)	Threshold (1bytes)	C W T U	DPT 5.004 2 bytes
12	Input A(long)	Threshold (1byte)	C W T U	DPT 7.001 1 byte

*These communication objects are for threshold control. Short/long press can send out different threshold value*

Objects „String (14bytes) controller“

Number	Name	Object Function	D...	G...	Length	C	R	W	T	U	Data Type	Priority
0	General	Heartbeat telegram			1 bit	C	-	-	T	-		Low
10	Input A	'1'-Enable/'0'-Disable			1 bit	C	-	W	-	-		Low
11	Input A (short)	String(14bytes) value			14 Byte	C	-	-	T	-		Low
12	Input A (long)	String(14bytes) value			14 Byte	C	-	-	T	-		Low

NO.	Object name	Function	Flags	Data type
11	Input A(short)	String(14 bytes)value	C T	DPT 16.000 2 bytes
12	Input A(long)	String(14 bytes)value	C T	DPT16.000 1 byte

*These communication objects are for string control. Short/long press can send out different string content*

Objects „Forced position controller“

Number	Name	Object Function	D...	Group Add...	Length	C	R	W	T	U	Data Type	Pri
0	General	Heartbeat telegram		1/2/3	1 bit	C	-	-	T	-	1 bit DPT_Enable	Low
10	Input A	Disable/Enable			1 bit	C	-	W	-	-	1 bit DPT_Enable	Low
11	Input A (closed)	Forced value (temperature)			2 Byte	C	-	W	T	U	2 byte float v...	Low
12	Input A (opened)	Forced value(0..255)			1 Byte	C	-	W	T	U		Low

NO.	Object name	Function	Flags	Data type
11	Input A(short)	Forced value (temperature)	C W T U	DPT 5.004 2 bytes
12	Input A(long)	Forced value (0...255)	C W T U	DPT 7.001 1 byte

*These communication objects are for forced value control. Short/long press can send out different control value*

Objects „Counter controller“

Number	Name	Object Function	D...	G...	Length	C	R	W	T	U	Data Type	Priority
0	General	Heartbeat telegram			1 bit	C	-	-	T	-		Low
10	Input A	'1'-Enable/'0'-Disable			1 bit	C	-	W	-	-		Low
11	Input A	Counter (0..255)			1 Byte	C	-	W	T	U		Low
12	Input A	Set counter end(0..255)			1 Byte	C	-	W	-	U		Low
13	Input A	Set counter (0..255)			1 Byte	C	-	W	-	U		Low

NO.	Object name	Function	Flags	Data type
11	Input A	Counter (0...255)	C W T U	DPT 5.004 1 byte
12	Input A	Set counter end(0...255)	C W U	DPT 5.004 1 byte
13	Input A	Set counter (0...255)	C W U	DPT 5.004 1 byte

*These communication objects are for counter control. Use object 11 to start the counter function, use object 12 to set the end of the counter; use object 13 to set the start of the counter*

Objects „Combination controller“

Number	Name	Object Function	D...	Group	Length	C	R	Y	T	U	Data Type	Priority
10	Input A	Disable/Enable			1 bit	C	-	Y	-	-	1 bit DPT_Enable	Low
10	General	Heartbeat telegram		1/2/3	1 bit	C	-	-	T	-	1 bit DPT_Enable	Low
11	Input A (closed)	COMB OBJ1 switching			1 bit	C	-	-	T	-	1 bit DPT_Switch	Low
12	Input A (closed)	COMB OBJ2 shutter			1 bit	C	-	-	T	-	1 bit DPT_UpDown	Low
13	Input A (closed)	COMB OBJ3 scene			1 Byte	C	-	-	T	-		Low
14	Input A (closed)	COMB OBJ4 sequence			1 bit	C	-	-	T	-	1 bit DPT_Start	Low
15	Input A (closed)	COMB OBJ5 percentage			1 Byte	C	-	-	T	-	8 bit unsigned...	Low
16	Input A (closed)	COMB OBJ6 threshold...			1 Byte	C	-	-	T	-		Low
17	Input A (closed)	COMB OBJ7 String(1...			14 Byte	C	-	-	T	-	Character string	Low
18	Input A (closed)	COMB OBJ8 switching			1 bit	C	-	-	T	-	1 bit DPT_Switch	Low
19	Input A (closed)	COMB OBJ9 switching			1 bit	C	-	-	T	-	1 bit DPT_Switch	Low
20	Input A (closed)	COMB OBJ10 switching			1 bit	C	-	-	T	-	1 bit DPT_Switch	Low
21	Input A (opened)	COMB OBJ1 switching			1 bit	C	-	-	T	-	1 bit DPT_Switch	Low
22	Input A (opened)	COMB OBJ2 switching			1 bit	C	-	-	T	-	1 bit DPT_Switch	Low
23	Input A (opened)	COMB OBJ3 switching			1 bit	C	-	-	T	-	1 bit DPT_Switch	Low
24	Input A (opened)	COMB OBJ4 switching			1 bit	C	-	-	T	-	1 bit DPT_Switch	Low
25	Input A (opened)	COMB OBJ5 switching			1 bit	C	-	-	T	-	1 bit DPT_Switch	Low
26	Input A (opened)	COMB OBJ6 switching			1 bit	C	-	-	T	-	1 bit DPT_Switch	Low
27	Input A (opened)	COMB OBJ7 switching			1 bit	C	-	-	T	-	1 bit DPT_Switch	Low
28	Input A (opened)	COMB OBJ8 switching			1 bit	C	-	-	T	-	1 bit DPT_Switch	Low
29	Input A (opened)	COMB OBJ9 switching			1 bit	C	-	-	T	-	1 bit DPT_Switch	Low
30	Input A (opened)	COMB OBJ10 switching			1 bit	C	-	-	T	-	1 bit DPT_Switch	Low

NO.	Object name	Function	Flags	Data type
11	Input A(short)	COMB OBJ1 switching	C T	DPT 1.001 1 bit
...				
20		COMB OBJ1 shutter	C T	DPT 1.008 1 bit
		COMB OBJ1 scene	C T	DPT 18.001 1 byte
		COMB OBJ1 sequence	C T	DPT 1.010 1 bit
		COMB OBJ1 percentage	C T	DPT 5.001 1 byte
		COMB OBJ1 Threshold(0...255)	C T	DPT 5.004 1 byte
		COMB OBJ1 Threshold(0...65535)	C T	DPT 7.001 2 byte
	COMB OBJ1 String (14 bytes)	C T	DPT 16.000 14 byte	

*These communication objects are for combination control. it contains switch, shutter, scene, sequence, percentage, threshold, string(14 bytes) controller, short press to send out these control telegrams*

21	Input A(long)	COMB OBJ1 switching	C T	DPT 1.001 1 bit
...				
30		COMB OBJ1 shutter	C T	DPT 1.008 1 bit
		COMB OBJ1 scene	C T	DPT 18.001 1 byte
		COMB OBJ1 sequence	C T	DPT 1.010 1 bit
		COMB OBJ1 percentage		DPT 5.001 1 byte
		COMB OBJ1 Threshold(0...255)	C T	DPT 5.004 1 byte
		COMB OBJ1 Threshold(0...65535)	C T	DPT 7.001 2 byte
	COMB OBJ1 String (14 bytes)	C T	DPT 16.000 14 byte	

*These communication objects are for combination control. it contains switch, shutter, scene, sequence, percentage, threshold, string(14 bytes) controller, long press to send out these control telegrams*

D.2 Temperature sensor

Objects „Switch controller“

Number	Name	Object Function	D...	Group	Length	C	R	W	T	U	Data Type	Priority
0	General	Heartbeat telegram		1/2/3	1 bit	C	-	-	T	-	1 bit DPT_Enable	Low
10	Input A	Temperature Report			2 Byte	C	R	-	T	-	2 byte float v...	Low
11	Input A	Switching			1 bit	C	-	W	T	U	1 bit DPT_Switch	Low
12	Input A	Change temperature threshold1			2 Byte	C	-	W	-	U	2 byte float v...	Low
13	Input A	Change temperature threshold2			2 Byte	C	-	W	-	U	2 byte float v...	Low
14	Input A	Forced switching			1 bit	C	-	W	-	U	1 bit DPT_Switch	Low

NO.	Object name	Function	Flags	Data type
11	Input A	Switching	C W T U	DPT 1.001 1 bit
12	Input A	Change temperature threshold 1/2	C W U	DPT 9.001 2 byte
14	Input A	Forced switching	C W U	DPT 9.001 1 bit

*These communication objects are for switch control. when temperature in the range, object 11 will send out the switch telegram to bus. Use object 12 to change the threshold 1 value, object 13 to change the threshold 2 value; use object 14 for forced switch control, then the temperature control will be invalid.*

Objects „Alarm controller“

Number	Name	Object Function	D...	Group	Length	C	R	W	T	U	Data Type	Priority
0	General	Heartbeat telegram		1/2/3	1 bit	C	-	-	T	-	1 bit DPT_Enable	Low
10	Input A	Temperature Report			2 Byte	C	R	-	T	-	2 byte Float v...	Low
11	Input A	Alarm			1 bit	C	-	W	T	U		Low
12	Input A	Change temperature threshold1			2 Byte	C	-	W	-	U	2 byte Float v...	Low
13	Input A	Change temperature threshold2			2 Byte	C	-	W	-	U	2 byte Float v...	Low
14	Input A	Forced alarm			1 bit	C	-	W	-	U	1 bit DPT_Switch	Low

NO.	Object name	Function	Flags	Data type
11	Input A	Alarm	C W T U	DPT 1.005 1 bit
12	Input A	Change temperature threshold 1/2	C W U	DPT 9.001 2 byte
14	Input A	Forced alarm	C W U	DPT 1.001 1 bit

*These communication objects are for alarm control. when temperature in the range, object 11 will send out the alarm telegram to bus. Use object 12 to change the threshold 1 value, object 13 to change the threshold 2 value; use object 14 for forced alarm control, then the temperature control will be invalid.*

Objects „Shutter controller“

Number	Name	Object Function	D...	Group	Length	C	R	W	T	U	Data Type	Priori
0	General	Heartbeat telegram		1/2/3	1 bit	C	-	-	T	-	1 bit DPT_Enable	Low
10	Input A	Temperature Report			2 Byte	C	R	-	T	-	2 byte float v...	Low
11	Input A	Move for shutter			1 bit	C	-	W	T	U	1 bit DPT_Up-Down	Low
12	Input A	Change temperature threshold1			2 Byte	C	-	W	-	U	2 byte float v...	Low
13	Input A	Change temperature threshold2			2 Byte	C	-	W	-	U	2 byte float v...	Low
14	Input A	Forced move			1 bit	C	-	W	-	U	1 bit DPT_Switch	Low

NO.	Object name	Function	Flags	Data type
11	Input A	Move for shutter	C W T U	DPT 1.008 1 bit
12 13	Input A	Change temperature threshold 1/2	C W U	DPT 9.001 2 byte
14	Input A	Forced move	C W U	DPT 1.001 1 bit

*These communication objects are for shutter control. when temperature in the range, object 11 will send out the up/down telegram to bus. Use object 12 to change the threshold 1 value, object 13 to change the threshold 2 value; use object 14 for forced moving control, then the temperature control be will invalid.*

Number	Name	Object Function	D...	Group	Length	C	R	W	T	U	Data Type	Priori
0	General	Heartbeat telegram		1/2/3	1 bit	C	-	-	T	-	1 bit DPT_Enable	Low
10	Input A	Temperature Report			2 Byte	C	R	-	T	-	2 byte float v...	Low
11	Input A	Call scene			1 Byte	C	-	W	T	U		Low
12	Input A	Change temperature threshold1			2 Byte	C	-	W	-	U	2 byte float v...	Low
13	Input A	Change temperature threshold2			2 Byte	C	-	W	-	U	2 byte float v...	Low
14	Input A	Forced scene			1 bit	C	-	W	-	U	1 bit DPT_Switch	Low

NO.	Object name	Function	Flags	Data type
11	Input A	Call scene	C W T U	DPT 18.001 1 bit
12 13	Input A	Change temperature threshold 1/2	C W U	DPT 9.001 2 byte
14	Input A	Forced scene	C W U	DPT 1.001 1 bit

*These communication objects are for scene control. when temperature in the range, object 11 will call the setting scene. Use object 12 to change the threshold 1 value, object 13 to change the threshold 2 value; use object 14 for forced scene control, then the temperature control will be invalid.*

Number	Name	Object Function	D...	Group	Length	C	R	W	T	U	Data Type	Priori
0	General	Heartbeat telegram		1/2/3	1 bit	C	-	-	T	-	1 bit DPT_Enable	Low
10	Input A	Temperature Report			2 Byte	C	R	-	T	-	2 byte float v...	Low
11	Input A	Sequence			1 bit	C	-	W	T	U	1 bit DPT_Start	Low
12	Input A	Change temperature threshold1			2 Byte	C	-	W	-	U	2 byte float v...	Low
13	Input A	Change temperature threshold2			2 Byte	C	-	W	-	U	2 byte float v...	Low
14	Input A	Forced sequence			1 bit	C	-	W	-	U	1 bit DPT_Switch	Low

NO.	Object name	Function	Flags	Data type
11	Input A	Sequence	C W T U	DPT 1.010 1 bit
12 13	Input A	Change temperature threshold 1/2	C W U	DPT 9.001 2 byte
14	Input A	Forced sequence	C W U	DPT 1.001



			1 bit
<p><i>These communication objects are for sequence control. when temperature in the range, object 11 will call the setting sequence. Use object 12 to change the threshold 1 value, object 13 to change the threshold 2 value; use object 14 for forced sequence control, then the temperature control will be invalid.</i></p>			

Objects „Percentage controller“												
Number	Name	Object Function	D...	Group	Length	C	R	W	T	U	Data Type	Priority
0	General	Heartbeat telegram		1/2/3	1 bit	C	-	-	T	-	1 bit DPT_Enable	Low
10	Input A	Temperature Report			2 Byte	C	R	-	T	-	2 byte float v...	Low
11	Input A	Percentage			1 Byte	C	-	W	T	U	8 bit unsigned...	Low
12	Input A	Change temperature threshold1			2 Byte	C	-	W	-	U	2 byte float v...	Low
13	Input A	Change temperature threshold2			2 Byte	C	-	W	-	U	2 byte float v...	Low
14	Input A	Forced percentage			1 bit	C	-	W	-	U	1 bit DPT_Switch	Low

NO.	Object name	Function	Flags	Data type
11	Input A	Percentage	C W T U	DPT 5.001 1 byte
12 13	Input A	Change temperature threshold 1/2	C W U	DPT 9.001 2 byte
14	Input A	Forced percentage	C W U	DPT 1.001 1 bit

*These communication objects are for percentage control. when temperature in the range, object 11 will send out the setting percentage value. Use object 12 to change the threshold 1 value, object 13 to change the threshold 2 value; use object 14 for forced percentage control, then the temperature control will be invalid.*

Objects „Threshold controller“												
Number	Name	Object Function	D...	Group	Length	C	R	W	T	U	Data Type	Priority
0	General	Heartbeat telegram		1/2/3	1 bit	C	-	-	T	-	1 bit DPT_Enable	Low
10	Input A	Temperature Report			2 Byte	C	R	-	T	-	2 byte float v...	Low
11	Input A...	Threshold value(1byte)			1 Byte	C	-	W	T	U	8 bit unsigned...	Low
12	Input A	Change temperature threshold1			2 Byte	C	-	W	-	U	2 byte float v...	Low
13	Input A	Change temperature threshold2			2 Byte	C	-	W	-	U	2 byte float v...	Low
14	Input A	Forced threshold value			1 bit	C	-	W	-	U	1 bit DPT_Switch	Low

NO.	Object name	Function	Flags	Data type
11	Input A	Threshold value(1 byte)	C W T U	DPT 5.001 1 byte
12 13	Input A	Change temperature threshold 1/2	C W U	DPT 9.001 2 byte
14	Input A	Forced threshold value	C W U	DPT 1.001 1 bit

*These communication objects are for threshold control. when temperature in the range, object 11 will send out the setting threshold value. Use object 12 to change the temperature threshold 1 value, object 13 to change the temperature threshold 2 value; use object 14 for forced threshold control, then the temperature control will be invalid.*

Objects „String (14bytes) controller“

Number	Name	Object Function	D...	Group...	Length	C	R	W	T	U	Data Type	Priority
0	General	Heartbeat telegram		1/2/3	1 bit	C	-	-	T	-	1 bit DPT_Enable	Low
10	Input A	Temperature Report			2 Byte	C	R	-	T	-	2 byte float v...	Low
11	Input A	String(14bytes) value			14 Byte	C	-	-	T	-	Character stri...	Low
12	Input A	Change temperature threshold1			2 Byte	C	-	W	-	U	2 byte float v...	Low
13	Input A	Change temperature threshold2			2 Byte	C	-	W	-	U	2 byte float v...	Low
14	Input A	Forced string			1 bit	C	-	W	-	U	1 bit DPT_Switch	Low

NO.	Object name	Function	Flags	Data type
11	Input A	String(14bytes) value	C W T U	DPT 16.000 1 byte
12 13	Input A	Change temperature threshold 1/2	C W U	DPT 9.001 2 byte
14	Input A	Forced string	C W U	DPT 1.001 1 bit

These communication objects are for string control. when temperature in the range, object 11 will send out the setting string content. Use object 12 to change the temperature threshold 1 value, object 13 to change the temperature threshold 2 value; use object 14 for forced string control, then the temperature control will be invalid.

Objects „Forced position controller“												
Number	Name	Object Function	D...	Group...	Length	C	R	W	T	U	Data Type	Priority
0	General	Heartbeat telegram		1/2/3	1 bit	C	-	-	T	-	1 bit DPT_Enable	Low
10	Input A	Temperature Report			2 Byte	C	R	-	T	-	2 byte float v...	Low
11	Input A...	Forced value (2bits)			2 bit	C	-	W	T	U	1 bit controll...	Low
12	Input A...	Forced value (2bits)			2 bit	C	-	W	T	U	1 bit controll...	Low
13	Input A	Change temperature threshold1			2 Byte	C	-	W	-	U	2 byte float v...	Low
14	Input A	Change temperature threshold2			2 Byte	C	-	W	-	U	2 byte float v...	Low

NO.	Object name	Function	Flags	Data type
11 12	Input A (in range/TEMP THR1)/ (out range/TEMP THR2)	Forced value(2 bits)	C W U	DPT 2.001 2 bit
13 14	Input A	Change temperature threshold 1/2	C W U	DPT 9.001 2 byte

These communication objects are for forced position control. Use object 11 to send out forced control telegram when temperature in range or on the threshold 1 value, object 12 to send out forced control telegram when temperature out of range or on the threshold 2 value; Use object 13 to change the temperature threshold 1 value, object 14 to change the temperature threshold 2 value.

Objects „Combination controller“

Number	Name	Object Function	D...	Length	C	R	W	T	U	Data Type	Pri
0	General	Heartbeat telegram		1 bit	C	-	-	T	-	1 bit DPT_Enable	Low
10	Input A	Temperature Report		2 Byte	C	R	-	T	-	2 byte float v...	Low
11	Input A	Change temperature thres...		2 Byte	C	-	W	-	U	2 byte float v...	Low
12	Input A	Change temperature thres...		2 Byte	C	-	W	-	U	2 byte float v...	Low
13	Input A (in range/TEMP THR1)	COMB OBJ1 switching		1 bit	C	-	-	T	-	1 bit DPT_Switch	Low
14	Input A (in range/TEMP THR1)	COMB OBJ2 alarm		1 bit	C	-	-	T	-		Low
15	Input A (in range/TEMP THR1)	COMB OBJ3 switching		1 bit	C	-	-	T	-	1 bit DPT_Switch	Low
16	Input A (in range/TEMP THR1)	COMB OBJ4 scene		1 Byte	C	-	-	T	-		Low
17	Input A (in range/TEMP THR1)	COMB OBJ5 sequence		1 bit	C	-	-	T	-	1 bit DPT_Start	Low
18	Input A (in range/TEMP THR1)	COMB OBJ6 threshold(0..255)		1 Byte	C	-	-	T	-		Low
19	Input A (in range/TEMP THR1)	COMB OBJ7 String(14bytes)		14 Byte	C	-	-	T	-	Character string	Low
20	Input A (in range/TEMP THR1)	COMB OBJ8 shutter		1 bit	C	-	-	T	-	1 bit DPT_UpDown	Low
21	Input A (in range/TEMP THR1)	COMB OBJ9 switching		1 bit	C	-	-	T	-	1 bit DPT_Switch	Low
22	Input A (in range/TEMP THR1)	COMB OBJ10 scene		1 Byte	C	-	-	T	-		Low
23	Input A (out range/TEMP THR2)	COMB OBJ1 switching		1 bit	C	-	-	T	-	1 bit DPT_Switch	Low
24	Input A (out range/TEMP THR2)	COMB OBJ2 alarm		1 bit	C	-	-	T	-		Low
25	Input A (out range/TEMP THR2)	COMB OBJ3 shutter		1 bit	C	-	-	T	-	1 bit DPT_UpDown	Low
26	Input A (out range/TEMP THR2)	COMB OBJ4 scene		1 Byte	C	-	-	T	-		Low
27	Input A (out range/TEMP THR2)	COMB OBJ5 sequence		1 bit	C	-	-	T	-	1 bit DPT_Start	Low
28	Input A (out range/TEMP THR2)	COMB OBJ6 sequence		1 bit	C	-	-	T	-	1 bit DPT_Start	Low
29	Input A (out range/TEMP THR2)	COMB OBJ7 percentage		1 Byte	C	-	-	T	-	8 bit unsigned...	Low
30	Input A (out range/TEMP THR2)	COMB OBJ8 threshold(0..255)		1 Byte	C	-	-	T	-		Low
31	Input A (out range/TEMP THR2)	COMB OBJ9 String(14bytes)		14 Byte	C	-	-	T	-	Character stri...	Low
32	Input A (out range/TEMP THR2)	COMB OBJ10 switching		1 bit	C	-	-	T	-	1 bit DPT_Switch	Low

NO.	Object name	Function	Flags	Data type
11 12	Input A	Change temperature thres1/2	C W U	DPT 9.001 2byte
13 ... 22	Input A(in range/TEMP THR1)	COMB OBJ1 switching	C T	DPT 1.001 1 bit
		COMB OBJ1 alarm	C T	DPT 1.005 1 bit
		COMB OBJ1 shutter	C T	DPT 1.008 1 bit
		COMB OBJ1 scene	C T	DPT 18.001 1 byte
		COMB OBJ1 sequence	C T	DPT 1.010 1 bit
		COMB OBJ1 percentage	C T	DPT 5.001 1 byte
		COMB OBJ1 Threshold(0...255)	C T	DPT 5.004 1 byte
		COMB OBJ1 Threshold(0...65535)	C T	DPT 7.001 2 byte
		COMB OBJ1 String (14 bytes)	C T	DPT 16.000 14 byte
<p><i>These communication objects are for combination control. Use object 11 to change the temperature threshold 1 value, object 12 to change the temperature threshold 2 value. Object 13-22 is for output setting, which contains switch, shutter, scene, sequence, percentage, threshold, string(14 bytes) controller. when temperature in range or on the threshold 1 value, will send out these control telegrams</i></p>				
23 ... 32		COMB OBJ1 switching	C T	DPT 1.001 1 bit
		COMB OBJ1 alarm	C T	DPT 1.005 1 bit
		COMB OBJ1 shutter	C T	DPT 1.008 1 bit

	Input A(out range/TEMP THR2)	COMB OBJ1 scene	C T	DPT 18.001 1 byte
		COMB OBJ1 sequence	C T	DPT 1.010 1 bit
		COMB OBJ1 percentage	C T	DPT 5.001 1 byte
		COMB OBJ1 Threshold(0...255)	C T	DPT 5.004 1 byte
		COMB OBJ1 Threshold(0...65535)	C T	DPT 7.001 2 byte

*These communication objects are for combination control. Object 23-32 is for output setting, which contains switch, shutter, scene, sequence, percentage, threshold, string(14 bytes) controller. when temperature out of range or on the threshold 2 value, will send out these control telegrams*

### D.3 Logical controller

Objects „Logical function A, Block A“							
Number	Name	Object Function	D.	Length	C R W T U	Data Type	Priorit.
0	General	Heartbeat telegram	1	1 bit	C - - T -	1 bit DPT_Enable	Low
10	Logic A	Dry contact status report	1	1 bit	C R - T -	1 bit DPT_Bool	Low
11	Logic A	Extern telegram <1> (4bytes)	4	4 Byte	C - W - U	4 byte unsigned...	Low
12	Logic A	Extern telegram <2> (1byte)	1	1 Byte	C - W - U		Low
13	Logic A	Extern telegram <3> (1bit)	1	1 bit	C - W - U	1 bit DPT_Switch	Low
14	Logic A	Extern telegram <4> (1bit)	1	1 bit	C - W - U	1 bit DPT_Switch	Low
15	Logic A	Extern telegram <5> (1bit)	1	1 bit	C - W - U	1 bit DPT_Switch	Low
16	Logic A:1	Switching	1	1 bit	C - W T U	1 bit DPT_Switch	Low
17	Logic A:2	Alarm	1	1 bit	C - W T U		Low
18	Logic A:3	Shutter	1	1 bit	C - W T U	1 bit DPT_UpDown	Low
19	Logic A:4	Shutter	1	1 bit	C - W T U	1 bit DPT_UpDown	Low
20	Logic A:5	Scene	1	1 Byte	C - W T U		Low
21	Logic A:6	Sequence	1	1 bit	C - W T U	1 bit DPT_Start	Low
22	Logic A:7	Sequence	1	1 bit	C - W T U	1 bit DPT_Start	Low
23	Logic A:8	Percentage (0%..100%)	1	1 Byte	C - W T U	8 bit unsigned...	Low
24	Logic A:9	Threshold(0..255)	1	1 Byte	C - W T U		Low
25	Logic A:10	String(14bytes)	14	14 Byte	C - - T -	Character string	Low
136	Logic E:1	Switching	1	1 bit	C - W T U	1 bit DPT_Switch	Low

NO.	Object name	Function	Flags	Data type
10	Logic A	Dry contact status report	C R T	DPT 1.002 1 bit

*This communication object is for dry contact status report. It will report its status to the bus when open/closed.*

11 ... 15	Logic A	Extern telegram<1> ... Extern telegram<5>	C W U	DPT 1.001 1bit DPT 4.001 1 byte DPT 7.001 2 byte DPT 12.001 4 byte
-----------------	---------	---	-------	---

*These communication objects are for external conditions of logic, these external telegram are provided by another devices in the system*

	Switching controller	C W T U	DPT 1.001 1bit
	Alarm controller	C W T U	DPT 1.005 1bit

16 ... 25	Logic A:1 ... Logic A:10	Shutter controller	C W T U	DPT 1.008 1bit
		Scene controller	C W T U	DPT 18.001 1byte
		Sequence controller	C W T U	DPT 1.010 1bit
		Percentage (0%..100%)	C W T U	DPT 5.001 1byte
		Threshold (0...255)	C W T U	DPT 5.004 1byte
		String(14bytes)	C W T U	DPT 7.001 2 byte

Set the outputs for true logic, logic A :1 to logic A:10, contains the control type about switching, alarm, shutter, scene, sequence, percentage, string (14 bytes).

Logical B, logical C, logical D are same as logic A.

136	Logic E:1	switching	C W T U	DPT 1.001 1 bit
		Alarm	C W T U	DPT 1.005 1 bit
		shutter	C W T U	DPT 1.008 1 bit
		scene	C W T U	DPT 18.001 1 byte
		Sequence	C W T U	DPT 1.010 1 bit
		Percentage (0%..100%)	C W T U	DPT 5.001 1 byte
		Threshold (0-255)	C W T U	DPT 5.004 1 byte
		Threshold (0-65535)	C W T U	DPT 7.001 1 byte
		String (14 bytes)	C W T U	DPT 16.000 14 byte

logic A-D logic status consist of the logic E's input, logic E will send out these control telegrams when true.

#### D.4 Dimming controller

Objects „General“											
Number	Name	Object Function	D.	Length	C	R	W	T	U	Data Type	Priority
0	General	Heartbeat telegram	:	1 bit	C	-	-	T	-	1 bit DFT_Enable	Low
5	General	Sequence 1	:	1 bit	C	-	Y	-	V	1 bit DFT_Start	Low
6	General	Sequence 2	:	1 bit	C	-	Y	-	V	1 bit DFT_Start	Low
7	General	Sequence 3	:	1 bit	C	-	Y	-	V	1 bit DFT_Start	Low
8	General	Sequence 4	:	1 bit	C	-	Y	-	V	1 bit DFT_Start	Low
9	General	Sequence 5	:	1 bit	C	-	Y	-	V	1 bit DFT_Start	Low

NO.	Object name	Function	Flags	Data type
5	General	Sequence 1	C W U	DPT 1.010
...		...		1 bit
9		Sequence 5		

These communication objects are for sequence output. The sequence will be controlled to stop/start when receive the 0/1 value

Objects „Output A“											
Number	Name	Object Function	D..	Length	C	R	W	T	U	Data Type	Prior
0	General	Heartbeat telegram		1 bit	C	-	-	T	-	1 bit DPT_Enable	Low
10	Output A	Channel output		1 bit	C	-	W	-	U	1 bit DPT_Switch	Low
13	Output A	Response status(1bit)		1 bit	C	R	-	T	-	1 bit DPT_Switch	Low
14	Output A	Response status(1byte)		1 Byte	C	R	-	T	-	8 bit unsigned...	Low
15	Output A	SYNC control relay		1 bit	C	-	-	T	-	1 bit DPT_Switch	Low
17	Output A	R/W total ON time		2 Byte	C	R	W	T	U		Low
18	Output A	Alarm when total ON time out		1 bit	C	R	-	T	-		Low
19	Output A	Staircase light		1 bit	C	-	W	-	U	1 bit DPT_Switch	Low
20	Output A	Change staircase light factor		1 Byte	C	-	W	-	U		Low
21	Output A	Alarm staircase light		1 bit	C	R	-	T	-		Low
22	Output A	Flashing		1 bit	C	-	W	-	U	1 bit DPT_Switch	Low
23	Output A	Scene(8bit)		1 Byte	C	-	W	-	U		Low
24	Output A	Scene dimming(4bit)		4 bit	C	-	W	-	U	3 bit controll...	Low
25	Output A	Threshold input		1 Byte	C	-	W	-	U		Low
26	Output A	Change threshold 1		1 Byte	C	-	W	-	U		Low
27	Output A	Change threshold 2		1 Byte	C	-	W	-	U		Low
28	Output A (PWM)	Heat with 1bit control		1 bit	C	-	W	-	U	1 bit DPT_Switch	Low
31	Output A (PWM)	TEMP threshold2 alarm		1 bit	C	R	-	T	-		Low
32	Output A (PWM)	Forced position		1 bit	C	-	W	-	U	1 bit DPT_Switch	Low

NO.	Object name	Function	Flags	Data type
10	Output A	Channel output	C W U	DPT 1.001 1 bit

*This communication object is for switch output. The output A will be controlled to on/off when receive the 0/1 value*

13 ... 27	Output A	Response status(1 bit)	C R T	DPT 1.001 1 bit
		Response status(1byte)	C R T	DPT 5.001 1 byte
		SYNC control relay	C T	DPT 1.001 1 bit
		Temperature report	CRT	DPT 9.001 2 byte
		R/W total ON time	CRWTU	DPT 7.007 1 bit
		Alarm when total ON time out	CRT	DPT 1.005 1 bit
		Staircase light	CWU	DPT 1.001 1 bit
		Change staircase light factor	CWU	DPT 5.004 1 byte
		Alarm staircase light	CRT	DPT 1.005 1 bit
		Flashing	C WU	DPT 1.001 1 bit
		Scene(8 bit)	C WU	DPT 18.001 1 byte
Scene dimming(4 bit)	C WU	DPT 3.007		

				4 bit
		Threshold input	C WU	DPT 5.004 1 byte
		Change threshold 1	C WU	DPT 5.004 1 byte
		Change threshold 1	C WU	DPT 5.004 1 byte
<i>These communication objects are for channel output A's function control.</i>				
<b>28</b>	Output A (PWM)	Heat with 1 bit control	CWU	DPT 1.001 1 bit
...		TEMP threshold2 alarm	CRT	DPT 1.005 1 bit
<b>32</b>		Forced position	CWU	DPT 1.001 1 bit
<i>These communication objects are for combination control, Note: Output B,C,D 's setting are all same as output A.</i>				

--- End of Document ---